

Powerful. Beautiful.
Excellence · Innovation

IPC21101
IPC22101
IPC24101



Shanghai Panelmate Electronics Co., Ltd.

10.1" WXGA Industrial Panel PC

PANELMATE
Creative HMI Solution



Features

- Display type: 10.1",10.4",12.1",12.2",15",15.6",17",18.5",19",21.5",27"
- Front panel/back cover: Aluminium-magnesium alloy
- Large aluminium fins design to ensure the reliability and heat dissipation
- Front panel/Rear: IP65 / IP20
- Screen Type: Single point resistive touchscreen,Multi-point capacitive touchscreen,Non-touch screen
- OS:Win XP, Win7,Win10/Win11, Win CE, LINUX
- Equipped with 2xIntel i210AT Gigabit network cards, 4xUSB ports
- Processor: Intel Celeron J6412(don't support Win XP,Win 7)/3855U/3865U and Intel skylake i3/i5/i7 multiple CPU options
- Extendable WIFI/4G
- Customized LOGO

Namely Rule

IPC2XXXXHP-xxxxK-4G-128G-xxxx

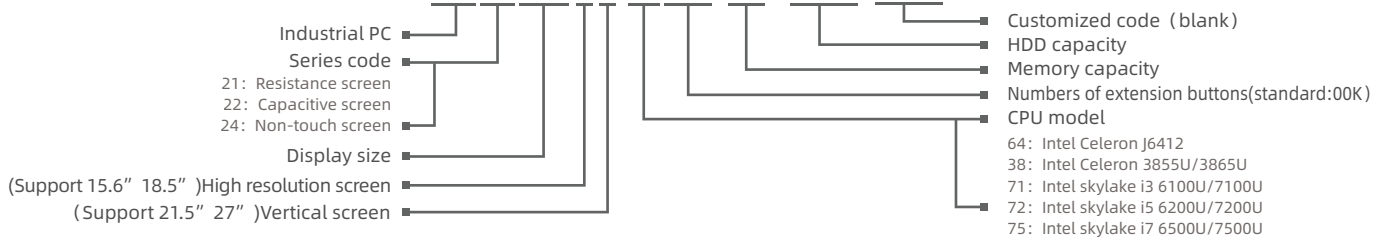

Specifications

Model	IPC21101&IPC22101&IPC24101			
Processor	CPU	Intel®Celeron® processor 3855U	Intel®Apollo Lake processor J3455	Intel®Core™i5 processor
	Frequency	Dual Core 1.6GHZ	Quad Core 1.5GHZ	Dual Core 2.3GHZ
	Cache	2MB	2MB L2 Cache	3MB Intel®Smart Cache
	Memory	DDR4-2133/2400MHZ,Max:16GB	1xSODIMM DDR3L 1333MHZ,Max:8GB	DDR4-2133/2400MHZ,Max:16GB
	Storage	1x2.5" SATA 3.0 +1 x mSATA		
I/O	Network (LAN)	2xIntel i210 1000Mbps RJ45 with surge protection		
	Audio	Realtek ALC662VD audio controller,support 5.1 channels		
	USB	4xUSB3.0/2.0		
	COM	2xRS232/RS485 with surge protection, RS485 support automatic flow control		
	Expansion Slot	1xMin-Pcie X1, Support 4G LTE/WIFI/BT with Sim card slot		
Power	Rear I/O	1xHDMI/2xGLAN/4xUSB/2xCOM/AUDIO/DC IN/Power Switch		
	Input Voltage	DC 9~36V		
Physical	Power	30W		
	Display Port	HDMI		
	Dimension (WxHxD/mm)	256.5 x 193 x 60 (10.10"x7.60"x2.36")		
	Open Size (WxH/mm)	248.5 x 185 (9.78"x7.28")		
	Net Weight(kg)	2.05		
LCD	Mounting	Embedded,Wall-mounted,VESA mounting		
	Display Type	10.1" WXGA TFT		
	Resolution	1280x800		
	Colors	16.7M		
	Active Area (WxH/mm)	216.96 x 135.60 (8.54"x5.34")		
	Backlight	LED		
	MTBF (hour)	30000hrs		
	Pixel Pitch (HxV)	0.1695x0.1695		
	Luminance(cd/m2)	400		
	Contrast Ratio	800:1		
Touchscreen	Viewing Angle	(L) 85/ (R) 85/ (U) 85/ (D) 85		
	Touch Type	Single point resistive touchscreen & Multi-point capacitive touchscreen & Non-touch screen		
	Light Transmission	>85%		
	Controller	USB interface		
	Driver Support	Windows7, WES7, Windows 10, Vxworks, Linux		
	Multi-touch	10 points		
Environment	Surface Hardness	Resistive touchscreen: Mohs' Number>= 3H; Capacitive touchscreen: Mohs' Number 7H		
	Operating Temperature	-20~70°C		
	Storage Temperature	-30~80°C		
	Relative Humidity	5~95% (Non condensation)		
	Shock	Operating 10G peak acceleration(11 ms duration), follow IEC 60068-2-27		
	Vibration	Operating Random Vibration Test 5~500Hz, 1Grms@with HDD;2Grms@with SSD, follow IEC 60068-2-64		
EMC	CE/FCC Class A			
Front Panel Protection	IP65			

IPC21101 & IPC22101 & IPC24101

Technical Drawings unit:mm

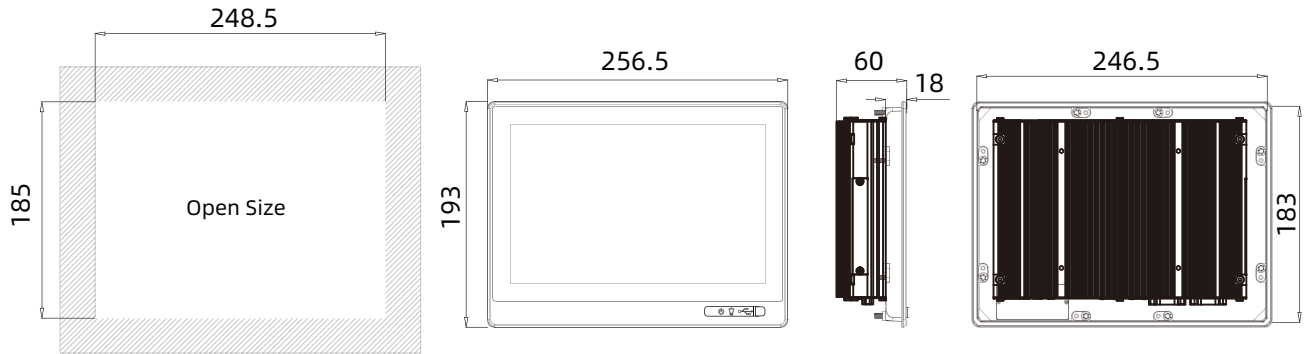

Panel Cutout Dimensions: 248.5 x 185mm (9.78 x 7.28in)

External I/O View

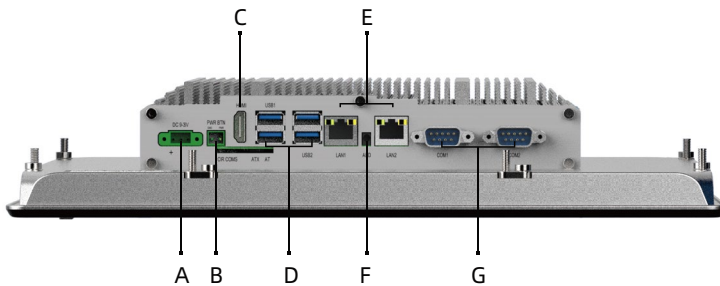

Interface definition:

- A: DC IN
- B: Power switch
- C: HDMI port
- D: 4xUSB 3.0/2.0
- E: 2xEthernet LAN
- F: Audio output
- G: 2xCOM

Ordering Information

Part Number	Description
IPC21101-3800K-4G-128G	10.1" TFT LCD / Resistive touch screen / No extension button / DC9~36V Input / Resolution 1280x800 / 3855U / 4G RAM / 128G / mSATA / 2xLAN / 4xUSB / 1xHDMI
IPC22101-3800K-4G-128G	10.1" TFT LCD / Capacitive touch screen / No extension button / DC9~36V Input / Resolution 1280x800 / 3855U / 4G RAM / 128G / mSATA / 2xLAN / 4xUSB / 1xHDMI
IPC24101-3800K-4G-128G	10.1" TFT LCD / Non-touch screen / No extension button / DC9~36V Input / Resolution 1280x800 / 3855U / 4G RAM / 128G / mSATA / 2xLAN / 4xUSB / 1xHDMI

Optional Accessories

mSATA	128G / 256G / 512G
2.5" HDD	512G / 1T / 2T
RAM	4G / 8G / 16G

Packing List

Terminal	2 pin spring clamp terminal
Terminal	3 pin screw terminals

Note: Package contents are subject to change without prior notice

Powerful. Beautiful.
Excellence · Innovation

IPC21104
IPC22104
IPC24104



Shanghai Panelmate Electronics Co., Ltd.

10.4" SVGA Industrial Panel PC



Features

- Display type: 10.1",10.4",12.1",12.2",15",15.6",17",18.5",19",21.5",27"
- Front panel/back cover: Aluminium-magnesium alloy
- Large aluminium fins design to ensure the reliability and heat dissipation
- Front panel/Rear: IP65 / IP20
- Screen Type: Single point resistive touchscreen,Multi-point capacitive touchscreen,Non-touch screen
- OS:Win XP, Win7,Win10/Win11, Win CE, LINUX
- Equipped with 2xIntel i210AT Gigabit network cards, 4xUSB ports
- Processor: Intel Celeron J6412(don't support Win XP,Win 7)/3855U/3865U and Intel skylake i3/i5/i7 multiple CPU options
- Extendable WIFI/4G
- Customized LOGO

Namely Rule

IPC2XXXXHP-xxxxK-4G-128G-xxxx

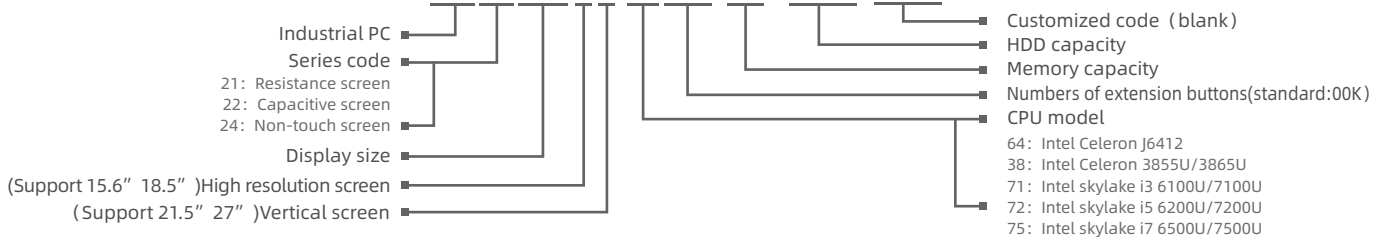

Specifications

Model	IPC21104&IPC22104&IPC24104			
Processor	CPU	Intel®Celeron® processor 3855U	Intel®Apollo Lake processor J3455	Intel®Core™i5 processor
	Frequency	Dual Core 1.6GHZ	Quad Core 1.5GHZ	Dual Core 2.3GHZ
	Cache	2MB	2MB L2 Cache	3MB Intel®Smart Cache
	Memory	DDR4-2133/2400MHz,Max:16GB	1xSODIMM DDR3L 1333MHZ,Max:8GB	DDR4-2133/2400MHz,Max:16GB
	Storage	1x2.5" SATA 3.0 +1 x mSATA		
I/O	Network (LAN)	2xIntel i210 1000Mbps RJ45 with surge protection		
	Audio	Realtek ALC662VD audio controller,support 5.1 channels		
	USB	4xUSB3.0/2.0		
	COM	2xRS232/RS485 with surge protection, RS485 support automatic flow control		
	Expansion Slot	1xMin-Pcle X1, Support 4G LTE/WIFI/BT with Sim card slot		
Power	Rear I/O	1xHDMI/2xGLAN/4xUSB/2xCOM/AUDIO/DC IN/Power Switch		
	Input Voltage	DC 9~36V		
Physical	Power	30W		
	Display Port	HDMI		
	Dimension (WxHxD/mm)	264 x 221.6 x 63.5 (10.39"x8.72"x2.50")		
	Open Size (WxH/mm)	253 x 210.6 (9.96"x8.29")		
	Net Weight(kg)	2.4		
LCD	Mounting	Embedded,Wall-mounted,VESA mounting		
	Display Type	10.4" WXGA TFT		
	Resolution	800 x 600		
	Colors	16.2M		
	Active Area (WxH/mm)	211.2 x 158.4 (8.31"x6.24")		
	Backlight	LED		
	MTBF (hour)	30000hrs		
	Pixel Pitch (HxV)	0.2063x0.2063		
	Luminance(cd/m2)	350		
	Contrast Ratio	900:1		
Touchscreen	Viewing Angle	(L) 75/ (R) 75/ (U) 75/ (D) 75		
	Touch Type	Single point resistive touchscreen & Multi-point capacitive touchscreen & Non-touch screen		
	Light Transmission	>85%		
	Controller	USB interface		
	Driver Support	Windows7, WES7, Windows 10, Vxworks, Linux		
Environment	Multi-touch	10 points		
	Surface Hardness	Resistive touchscreen: Mohs' Number>= 3H; Capacitive touchscreen: Mohs' Number 7H		
	Operating Temperature	-20~70°C		
	Storage Temperature	-20~70°C		
	Relative Humidity	5~95% (Non condensation)		
	Shock	Operating 10G peak acceleration(11 ms duration), follow IEC 60068-2-27		
	Vibration	Operating Random Vibration Test 5~500Hz, 1Grms@with HDD; 2Grms@with SSD, follow IEC 60068-2-64		
EMC	CE/FCC Class A			
Front Panel Protection	IP65			

IPC21104 & IPC22104 & IPC24104

Technical Drawings unit:mm

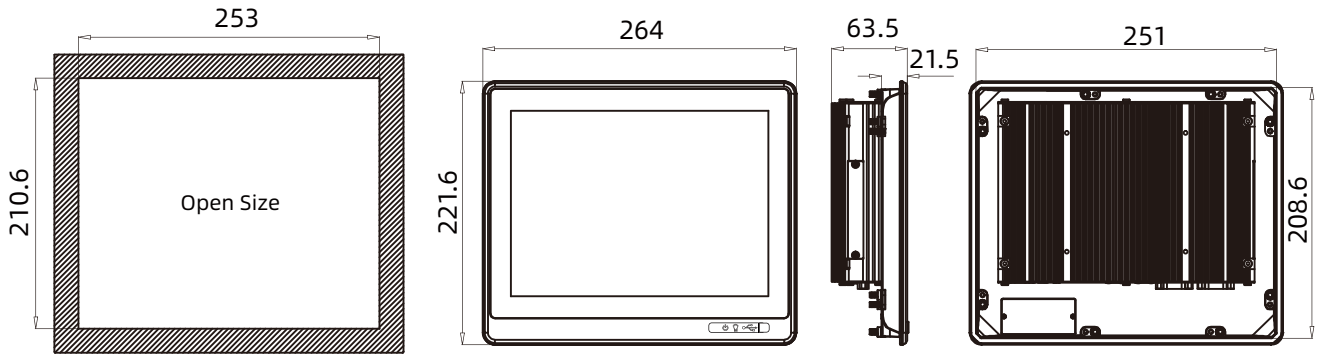

Panel Cutout Dimensions: 253 x 210.6mm (9.96 x 8.29in)

External I/O View

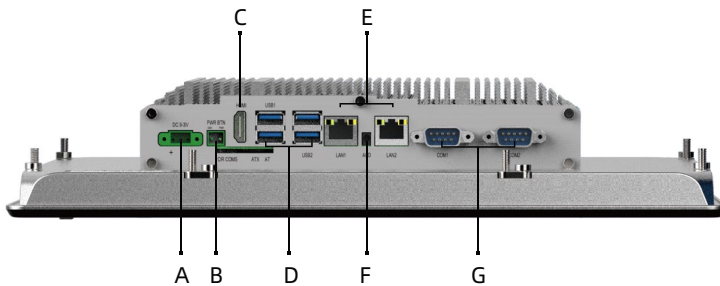

Interface definition:

- A: DC IN
- B: Power switch
- C: HDMI port
- D: 4xUSB 3.0/2.0
- E: 2xEthernet LAN
- F: Audio output
- G: 2xCOM

Ordering Information

Part Number	Description
IPC21104-3800K-4G-128G	10.4" TFT LCD / Resistive touch screen / No extension button / DC9~36V Input / Resolution 1024x768 / 3855U / 4G RAM / 128G / mSATA / 2xLAN / 4xUSB / 1xHDMI
IPC22104-3800K-4G-128G	10.4" TFT LCD / Capacitive touch screen / No extension button / DC9~36V Input / Resolution 1024x768 / 3855U / 4G RAM / 128G / mSATA / 2xLAN / 4xUSB / 1xHDMI
IPC24104-3800K-4G-128G	10.4" TFT LCD / Non-touch screen / No extension button / DC9~36V Input / Resolution 1024x768 / 3855U / 4G RAM / 128G / mSATA / 2xLAN / 4xUSB / 1xHDMI

Optional Accessories

mSATA	128G / 256G / 512G
2.5" HDD	512G / 1T / 2T
RAM	4G / 8G / 16G

Packing List

Terminal	2 pin spring clamp terminal
Terminal	3 pin screw terminals

Note: Package contents are subject to change without prior notice

Powerful. Beautiful.
Excellence · Innovation

IPC21121
IPC22121
IPC24121



Shanghai Panelmate Electronics Co., Ltd.

12.1" XGA Industrial Panel PC

IPC21121 & IPC22121 & IPC24121



Features

- Display type: 10.1",10.4",12.1",12.2",15",15.6",17",18.5",19",21.5",27"
- Front panel/back cover: Aluminium-magnesium alloy
- Large aluminium fins design to ensure the reliability and heat dissipation
- Front panel/Rear: IP65 / IP20
- Screen Type: Single point resistive touchscreen/Multi-point capacitive touchscreen/Non-touch screen
- OS:Win XP, Win7,Win10/Win11, Win CE, LINUX
- Equipped with 2xIntel i210AT Gigabit network cards, 4xUSB ports
- Processor: Intel Celeron J6412(don't support Win XP,Win 7)/3855U/3865U and Intel skylake i3/i5/i7 multiple CPU options
- Extendable WIFI/4G
- Customized LOGO

Namely Rule

IPC2XXXXHP-xxxxK-4G-128G-xxxx

- Industrial PC
- Series code
- 21: Resistance screen
- 22: Capacitive screen
- 24: Non-touch screen
- Display size
- (Support 15.6" 18.5")High resolution screen
- (Support 21.5" 27")Vertical screen

- Customized code (blank)
- HDD capacity
- Memory capacity
- Numbers of extension buttons(standard:00K)
- CPU model
- 64: Intel Celeron J6412
- 38: Intel Celeron 3855U/3865U
- 71: Intel skylake i3 6100U/7100U
- 72: Intel skylake i5 6200U/7200U
- 75: Intel skylake i7 6500U/7500U

Specifications

Model	IPC21121&IPC22121&IPC24121			
Processor	CPU	Intel®Celeron® processor 3855U	Intel®Apollo Lake processor J3455	Intel®Core™i5 processor
	Frequency	Dual Core 1.6GHZ	Quad Core 1.5GHZ	Dual Core 2.3GHZ
	Cache	2MB	2MB L2 Cache	3MB Intel®Smart Cache
	Memory	DDR4-2133/2400MHZ,Max:16GB	1xSODIMM DDR3L 1333MHZ,Max:8GB	DDR4-2133/2400MHZ,Max:16GB
	Storage	1x2.5" SATA 3.0 +1 x mSATA		
I/O	Network (LAN)	2xIntel i210 1000Mbps RJ45 with surge protection		
	Audio	Realtek ALC662VD audio controller,support 5.1 channels		
	USB	4xUSB3.0/2.0		
	COM	2xRS232/RS485 with surge protection, RS485 support automatic flow control		
	Expansion Slot	1xMin-Pcie X1, Support 4G LTE/WIFI/BT with Sim card slot		
	Rear I/O	1xHDMI/2xGLAN/4xUSB/2xCOM/AUDIO/DC IN/Power Switch		
Power	Input Voltage	DC 9~36V		
	Power	34W		
Physical	Display Port	HDMI		
	Dimension (WxHxD/mm)	306 x 259 x 63.5 (12.04"x10.20"x2.50")		
	Open Size (WxH/mm)	295 x 248 (11.61"x9.76")		
	Net Weight(kg)	3		
	Mounting	Embedded,Wall-mounted,VESA mounting		
LCD	Display Type	12.1" XGA TFT		
	Resolution	1024x768		
	Colors	16.7M		
	Active Area (WxH/mm)	245.76 x 184.32 (9.68"x7.26")		
	Backlight	LED		
	MTBF (hour)	50000hrs		
	Pixel Pitch (HxV)	0.24x0.24		
	Luminance(cd/m2)	350		
	Contrast Ratio	800:1		
	Viewing Angle	(L) 80/ (R) 80/ (U) 80/ (D) 80		
Touchscreen	Touch Type	Single point resistive touchscreen & Multi-point capacitive touchscreen & Non-touch screen		
	Light Transmission	>85%		
	Controller	USB interface		
	Driver Support	Windows7, WES7, Windows 10, Vxworks, Linux		
	Multi-touch	10 points		
	Surface Hardness	Resistive touchscreen: Mohs' Number>= 3H; Capacitive touchscreen: Mohs' Number 7H		
Environment	Operating Temperature	-20~70°C		
	Storage Temperature	-30~80°C		
	Relative Humidity	5~95% (Non condensation)		
	Shock	Operating 10G peak acceleration(11 ms duration), follow IEC 60068-2-27		
	Vibration	Operating Random Vibration Test 5~500Hz, 1Grms@with HDD;2Grms@with SSD, follow IEC 60068-2-64		
	EMC	CE/FCC Class A		
Front Panel Protection	IP65			

Technical Drawings unit:mm

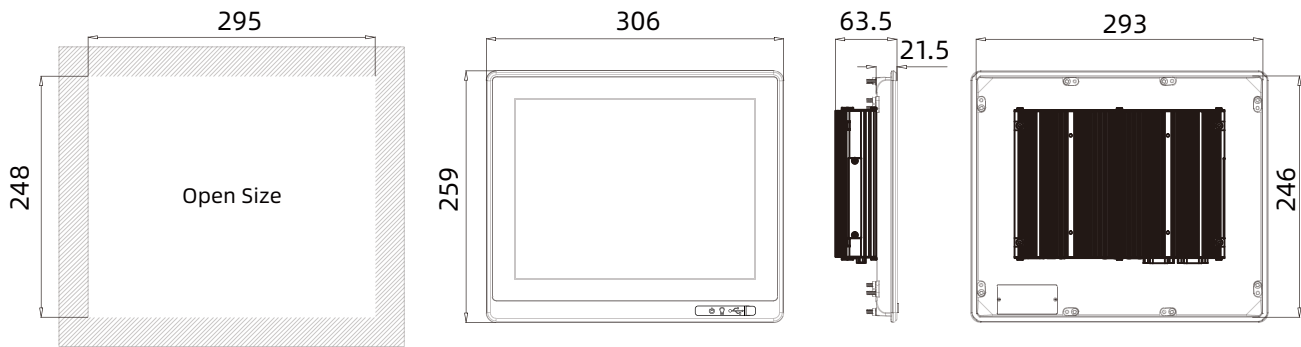

Panel Cutout Dimensions: 295 x 248mm (11.61 x 9.76in)

External I/O View

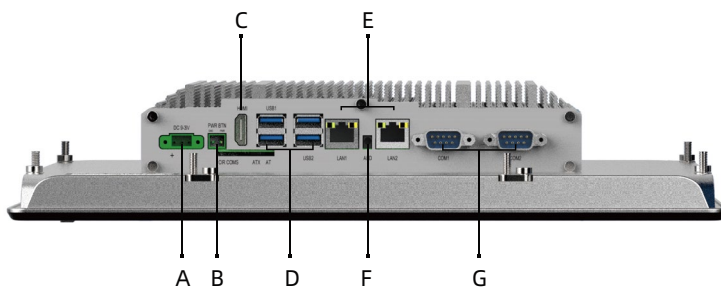

Interface definition:

- A: DC IN
- B: Power switch
- C: HDMI port
- D: 4xUSB 3.0/2.0
- E: 2xEthernet LAN
- F: Audio output
- G: 2xCOM

Ordering Information

Part Number	Description
IPC21121-3800K-4G-128G	12.1" TFT LCD / Resistive touch screen / No extension button / DC9~36V Input / Resolution 1024x768 / 3855U / 4G RAM / 128G / mSATA / 2xLAN / 4xUSB / 1xHDMI
IPC22121-3800K-4G-128G	12.1" TFT LCD / Capacitive touch screen / No extension button / DC9~36V Input / Resolution 1024x768 / 3855U / 4G RAM / 128G / mSATA / 2xLAN / 4xUSB / 1xHDMI
IPC24121-3800K-4G-128G	12.1" TFT LCD / Non-touch screen / No extension button / DC9~36V Input / Resolution 1024x768 / 3855U / 4G RAM / 128G / mSATA / 2xLAN / 4xUSB / 1xHDMI

Optional Accessories

mSATA	128G / 256G / 512G
2.5" HDD	512G / 1T / 2T
RAM	4G / 8G / 16G

Packing List

Terminal	2 pin spring clamp terminal
Terminal	3 pin screw terminals

Note: Package contents are subject to change without prior notice

Powerful. Beautiful.
Excellence · Innovation

IPC21122
IPC22122
IPC24122



Shanghai Panelmate Electronics Co., Ltd.

12.2" WXGA Industrial Panel PC

IPC21122 & IPC22122 & IPC24122



Features

- Display type: 10.1",10.4",12.1",12.2",15",15.6",17",18.5",19",21.5",27"
- Front panel/back cover: Aluminium-magnesium alloy
- Large aluminium fins design to ensure the reliability and heat dissipation
- Front panel/Rear: IP65 / IP20
- Screen Type: Single point resistive touchscreen/Multi-point capacitive touchscreen/Non-touch screen
- OS: Win XP, Win7,Win10/Win11, Win CE, LINUX
- Equipped with 2xIntel i210AT Gigabit network cards, 4xUSB ports
- Processor: Intel Celeron J6412(don't support Win XP,Win 7)/3855U/3865U and Intel skylake i3/i5/i7 multiple CPU options
- Extendable WIFI/4G
- Customized LOGO

Namely Rule

IPC2XXXXHP-xxxxK-4G-128G-xxxx

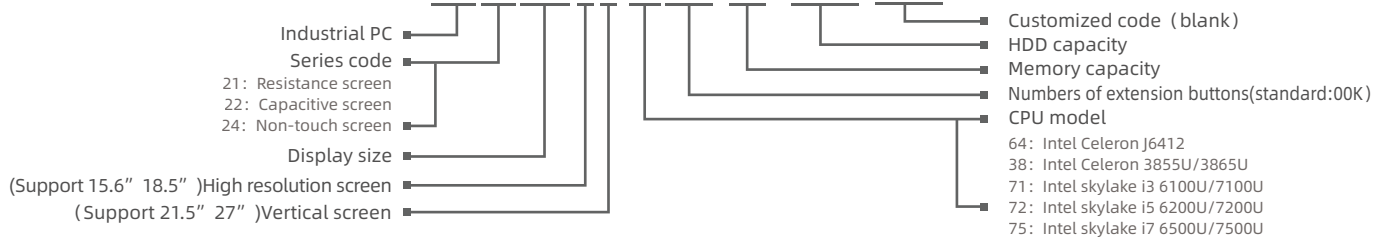

Specifications

Model	IPC21122&IPC22122&IPC24122			
Processor	CPU	Intel®Celeron® processor 3855U	Intel®Apollo Lake processor J3455	Intel®Core™i5 processor
	Frequency	Dual Core 1.6GHZ	Quad Core 1.5GHZ	Dual Core 2.3GHZ
	Cache	2MB	2MB L2 Cache	3MB Intel®Smart Cache
	Memory	DDR4-2133/2400MHz,Max:16GB	1xSODIMM DDR3L 1333MHz,Max:8GB	DDR4-2133/2400MHz,Max:16GB
	Storage	1x2.5" SATA 3.0 +1 x mSATA		
I/O	Network (LAN)	2xIntel i210 1000Mbps RJ45 with surge protection		
	Audio	Realtek ALC662VD audio controller,support 5.1 channels		
	USB	4xUSB3.0/2.0		
	COM	2xRS232/RS485 with surge protection, RS485 support automatic flow control		
	Expansion Slot	1xMin-Pcie X1, Support 4G LTE/WIFI/BT with Sim card slot		
Power	Rear I/O	1xHDMI/2xGLAN/4xUSB/2xCOM/AUDIO/DC IN/Power Switch		
	Input Voltage	DC 9~36V		
Physical	Power	34W		
	Display Port	HDMI		
	Dimension (WxHxD/mm)	308.3 x 226.8 x 63.5 (12.14"x8.93"x2.50")		
	Open Size (WxH/mm)	297 x 216 (11.69"x8.50")		
	Net Weight(kg)	3.55		
LCD	Mounting	Embedded,Wall-mounted,VESA mounting		
	Display Type	12.2" WXGA TFT		
	Resolution	1280x800		
	Colors	16.7M		
	Active Area (WxH/mm)	262 x 164 (10.31"x6.46")		
	Backlight	LED		
	MTBF (hour)	50000hrs		
	Pixel Pitch (HxV)	0.2052x0.2052		
	Luminance(cd/m2)	450		
	Contrast Ratio	1000:1		
Touchscreen	Viewing Angle	(L) 85/ (R) 85/ (U) 85/ (D) 85		
	Touch Type	Single point resistive touchscreen & Multi-point capacitive touchscreen& Non-touch screen		
	Light Transmission	>85%		
	Controller	USB interface		
	Driver Support	Windows7, WES7, Windows 10, Vxworks, Linux		
Environment	Multi-touch	10 points		
	Surface Hardness	Resistive touchscreen: Mohs' Number>= 3H; Capacitive touchscreen: Mohs' Number 7H		
	Operating Temperature	-20~70°C		
	Storage Temperature	-30~80°C		
	Relative Humidity	5~95% (Non condensation)		
Front Panel Protection	Shock	Operating 10G peak acceleration(11 ms duration), follow IEC 60068-2-27		
	Vibration	Operating Random Vibration Test 5~500Hz, 1Grms@with HDD; 2Grms@with SSD, follow IEC 60068-2-64		
	EMC	CE/FCC Class A		
	Front Panel Protection	IP65		

IPC21122 & IPC22122 & IPC24122

Technical Drawings unit:mm

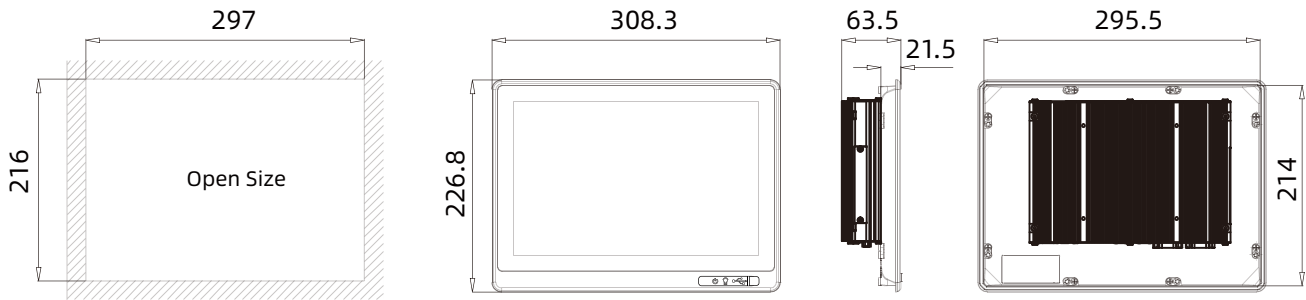

Panel Cutout Dimensions: 297 x 216mm (11.69 x 8.50in)

External I/O View

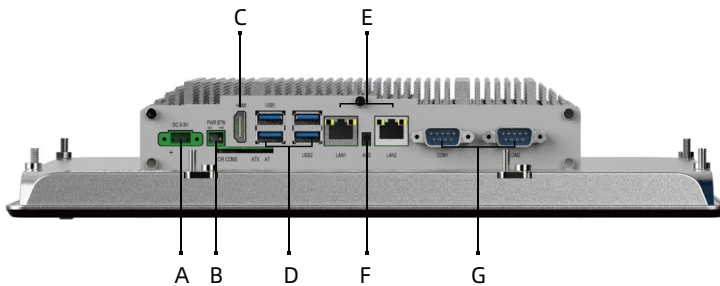

Interface definition:

- A: DC IN
- B: Power switch
- C: HDMI port
- D: 4xUSB 3.0/2.0
- E: 2xEthernet LAN
- F: Audio output
- G: 2xCOM

Ordering Information

Part Number	Description
IPC21122-3800K-4G-128G	12.2" TFT LCD / Resistive touch screen / No extension button / DC9~36V Input / Resolution 1280x800 / 3855U / 4G RAM / 128G / mSATA / 2xLAN / 4xUSB / 1xHDMI
IPC22122-3800K-4G-128G	12.2" TFT LCD / Capacitive touch screen / No extension button / DC9~36V Input / Resolution 1280x800 / 3855U / 4G RAM / 128G / mSATA / 2xLAN / 4xUSB / 1xHDMI
IPC24122-3800K-4G-128G	12.2" TFT LCD / Non-touch screen / No extension button / DC9~36V Input / Resolution 1280x800 / 3855U / 4G RAM / 128G / mSATA / 2xLAN / 4xUSB / 1xHDMI

Optional Accessories

mSATA	128G / 256G / 512G
2.5" HDD	512G / 1T / 2T
RAM	4G / 8G / 16G

Packing List

Terminal	2 pin spring clamp terminal
Terminal	3 pin screw terminals

Note: Package contents are subject to change without prior notice

Powerful. Beautiful.

Excellence · Innovation

IPC21150

IPC22150

IPC24150



Shanghai Panelmate Electronics Co., Ltd.

15" XGA Industrial Panel PC

PANELMATE
Creative HMI Solution

IPC21150 & IPC22150 & IPC24150



Features

- Display type: 10.1",10.4",12.1",12.2",15",15.6",17",18.5",19",21.5",27"
- Front panel/back cover: Aluminium-magnesium alloy
- Large aluminium fins design to ensure the reliability and heat dissipation
- Front panel/Rear: IP65 / IP20
- Screen Type: Single point resistive touchscreen/Multi-point capacitive touchscreen/Non-touch screen
- OS:Win XP, Win7,Win10/Win11, Win CE, LINUX
- Equipped with 2xIntel i210AT Gigabit network cards, 4xUSB ports
- Processor: Intel Celeron J6412(don't support Win XP,Win 7)/3855U/3865U and Intel skylake i3/i5/i7 multiple CPU options
- Extendable WIFI/4G
- Customized LOGO

Namely Rule

IPC2XXXXHP-xxxxK-4G-128G-xxxx

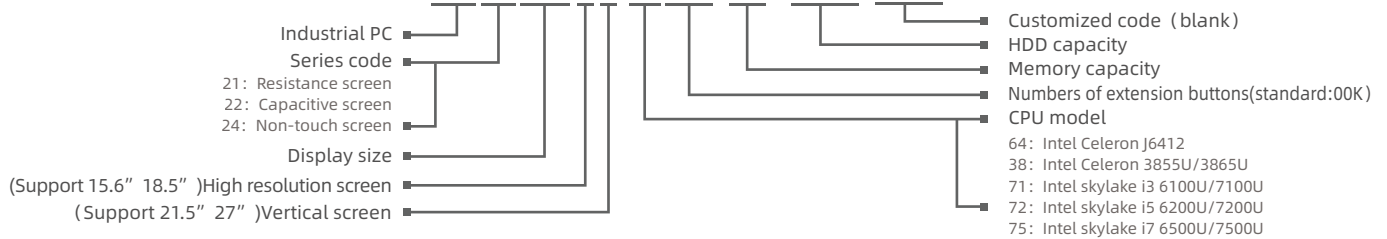

Specifications

Model	IPC21150&IPC22150&IPC24150			
Processor	CPU	Intel®Celeron® processor 3855U	Intel®Apollo Lake processor J3455	Intel®Core™i5 processor
	Frequency	Dual Core 1.6GHZ	Quad Core 1.5GHZ	Dual Core 2.3GHZ
	Cache	2MB	2MB L2 Cache	3MB Intel®Smart Cache
	Memory	DDR4-2133/2400MHz,Max:16GB	1xSODIMM DDR3L 1333MHZ,Max:8GB	DDR4-2133/2400MHz,Max:16GB
	Storage	1x2.5" SATA 3.0 +1 x mSATA		
I/O	Network (LAN)	2xIntel i210 1000Mbps RJ45 with surge protection		
	Audio	Realtek ALC662VD audio controller,support 5.1 channels		
	USB	4xUSB3.0/2.0		
	COM	2xRS232/RS485 with surge protection, RS485 support automatic flow control		
	Expansion Slot	1xMin-Pcie X1, Support 4G LTE/WIFI/BT with Sim card slot		
Power	Rear I/O	1xHDMI/2xGLAN/4xUSB/2xCOM/AUDIO/DC IN/Power Switch		
	Input Voltage	DC 9~36V		
Physical	Power	36W		
	Display Port	HDMI		
	Dimension (WxHxD/mm)	353 x 296 x 63.6 (13.9"x11.64"x2.5")		
	Open Size (WxH/mm)	342 x 285 (13.46"x11.22")		
	Net Weight(kg)	4		
LCD	Mounting	Embedded,Wall-mounted,VESA mounting		
	Display Type	15" XGA TFT		
	Resolution	1024x768		
	Colors	16.7M		
	Active Area (WxH/mm)	304.1 x 228.1 (11.97"x8.98")		
	Backlight	LED		
	MTBF (hour)	50000hrs		
	Pixel Pitch (HxV)	0.297x0.297		
	Luminance(cd/m2)	420		
	Contrast Ratio	800:1		
Touchscreen	Viewing Angle	(L) 80/ (R) 80/ (U) 80/ (D) 80		
	Touch Type	Single point resistive touchscreen & Multi-point capacitive touchscreen & Non-touch screen		
	Light Transmission	>85%		
	Controller	USB interface		
	Driver Support	Windows7, WES7, Windows 10, Vxworks, Linux		
Environment	Multi-touch	10 points		
	Surface Hardness	Resistive touchscreen: Mohs' Number>= 3H; Capacitive touchscreen: Mohs' Number 7H		
Environment	Operating Temperature	-10~65°C		
	Storage Temperature	-20~70°C		
	Relative Humidity	5~95% (Non condensation)		
	Shock	Operating 10G peak acceleration(11 ms duration), follow IEC 60068-2-27		
	Vibration	Operating Random Vibration Test 5~500Hz, 1Grms@with HDD; 2Grms@with SSD, follow IEC 60068-2-64		
	EMC	CE/FCC Class A		
Front Panel Protection	IP65			

Technical Drawings unit:mm

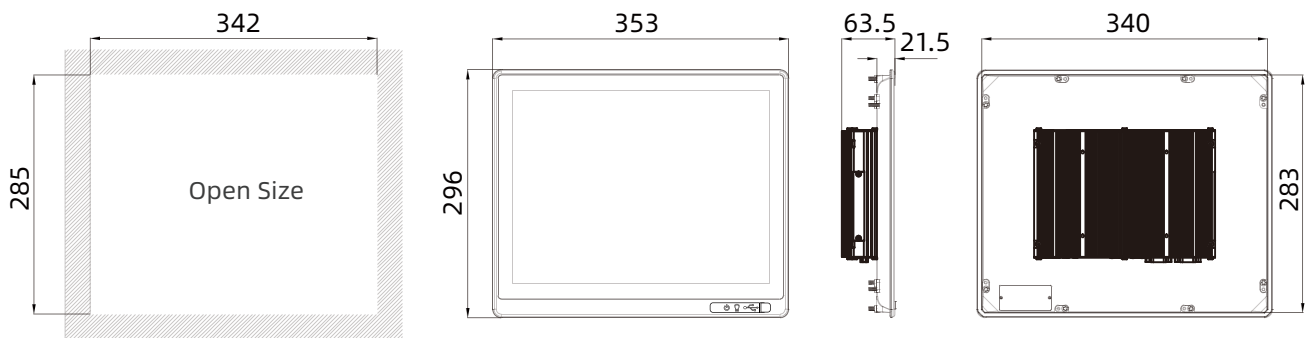

Panel Cutout Dimensions: 342 x 285mm (13.46 x 11.22in)

External I/O View

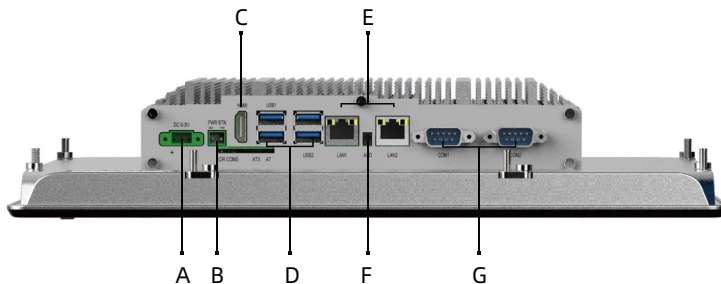

Interface definition:

- A: DC IN
- B: Power switch
- C: HDMI port
- D: 4xUSB 3.0/2.0
- E: 2xEthernet LAN
- F: Audio output
- G: 2xCOM

Ordering Information

Part Number	Description
IPC21150-3800K-4G-128G	15" TFT LCD / Resistive touch screen / No extension button / DC9~36V Input / Resolution 1024x768 / 3855U / 4G RAM / 128G / mSATA / 2xLAN / 4xUSB / 1xHDMI
IPC22150-3800K-4G-128G	15" TFT LCD / Capacitive touch screen / No extension button / DC9~36V Input / Resolution 1024x768 / 3855U / 4G RAM / 128G / mSATA / 2xLAN / 4xUSB / 1xHDMI
IPC24150-3800K-4G-128G	15" TFT LCD / Non-touch screen / No extension button / DC9~36V Input / Resolution 1024x768 / 3855U / 4G RAM / 128G / mSATA / 2xLAN / 4xUSB / 1xHDMI

Optional Accessories

mSATA	128G / 256G / 512G
2.5" HDD	512G / 1T / 2T
RAM	4G / 8G / 16G

Packing List

Terminal	2 pin spring clamp terminal
Terminal	3 pin screw terminals

Note: Package contents are subject to change without prior notice

Powerful. Beautiful.
Excellence · Innovation

IPC21156
IPC22156
IPC24156



Shanghai Panelmate Electronics Co., Ltd.

15.6" WXGA Industrial Panel PC

IPC21156 & IPC22156 & IPC24156



Features

- Display type: 10.1",10.4",12.1",12.2",15",15.6",17",18.5",19",21.5",27"
- Front panel/back cover: Aluminium-magnesium alloy
- Large aluminium fins design to ensure the reliability and heat dissipation
- Front panel/Rear: IP65 / IP20
- Screen Type: Single point resistive touchscreen/Multi-point capacitive touchscreen/Non-touch screen
- OS:Win XP, Win7,Win10/Win11, Win CE, LINUX
- Equipped with 2xIntel i210AT Gigabit network cards, 4xUSB ports
- Processor: Intel Celeron J6412(don't support Win XP,Win 7)/3855U/3865U and Intel skylake i3/i5/i7 multiple CPU options
- Extendable WIFI/4G
- Customized LOGO

Namely Rule

IPC2XXXXHP-xxxxK-4G-128G-xxxx

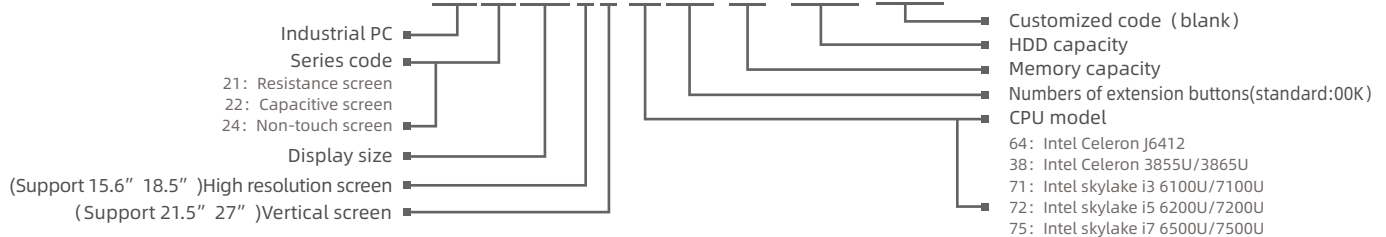

Specifications

Model	IPC21156&IPC22156&IPC24156			
Processor	CPU	Intel®Celeron® processor 3855U	Intel®Apollo Lake processor J3455	Intel®Core™i5 processor
	Frequency	Dual Core 1.6GHZ	Quad Core 1.5GHZ	Dual Core 2.3GHZ
	Cache	2MB	2MB L2 Cache	3MB Intel®Smart Cache
	Memory	DDR4-2133/2400MHz,Max:16GB	1xSODIMM DDR3L 1333MHZ,Max:8GB	DDR4-2133/2400MHz,Max:16GB
	Storage	1x2.5" SATA 3.0 +1 x mSATA		
I/O	Network (LAN)	2xIntel i210 1000Mbps RJ45 with surge protection		
	Audio	Realtek ALC662VD audio controller,support 5.1 channels		
	USB	4xUSB3.0/2.0		
	COM	2xRS232/RS485 with surge protection, RS485 support automatic flow control		
	Expansion Slot	1xMin-Pcie X1, Support 4G LTE/WIFI/BT with Sim card slot		
	Rear I/O	1xHDMI/2xGLAN/4xUSB/2xCOM/AUDIO/DC IN/Power Switch		
Power	Input Voltage	DC 9~36V		
	Power	43W		
Physical	Display Port	HDMI		
	Dimension (WxHxD/mm)	396 x 263 x 68.5 (15.59"x10.35"x2.70")		
	Open Size (WxH/mm)	385 x 253 (15.16"x9.96")		
	Net Weight(kg)	4.25		
	Mounting	Embedded, Wall-mounted, VESA mounting		
LCD	Display Type	15.6" WXGA TFT		
	Resolution	1366x768		
	Colors	16.7M		
	Active Area (WxH/mm)	344.23 x 193.54 (13.55"x7.62")		
	Backlight	LED		
	MTBF (hour)	50000hrs		
	Pixel Pitch (HxV)	0.252x0.252		
	Luminance(cd/m2)	300		
	Contrast Ratio	500:1		
Viewing Angle	(L) 85/ (R) 85/ (U) 85/ (D) 85			
Touchscreen	Touch Type	Single point resistive touchscreen & Multi-point capacitive touchscreen& Non-touch screen		
	Light Transmission	>85%		
	Controller	USB interface		
	Driver Support	Windows7, WES7, Windows 10, Vxworks, Linux		
	Multi-touch	10 points		
	Surface Hardness	Resistive touchscreen: Mohs' Number>= 3H; Capacitive touchscreen: Mohs' Number 7H		
Environment	Operating Temperature	0~60°C		
	Storage Temperature	-20~60°C		
	Relative Humidity	5~95% (Non condensation)		
	Shock	Operating 10G peak acceleration(11 ms duration), follow IEC 60068-2-27		
	Vibration	Operating Random Vibration Test 5~500Hz, 1Grms@with HDD; 2Grms@with SSD, follow IEC 60068-2-64		
	EMC	CE/FCC Class A		
	Front Panel Protection	IP65		

IPC21156 & IPC22156 & IPC24156

Technical Drawings unit:mm

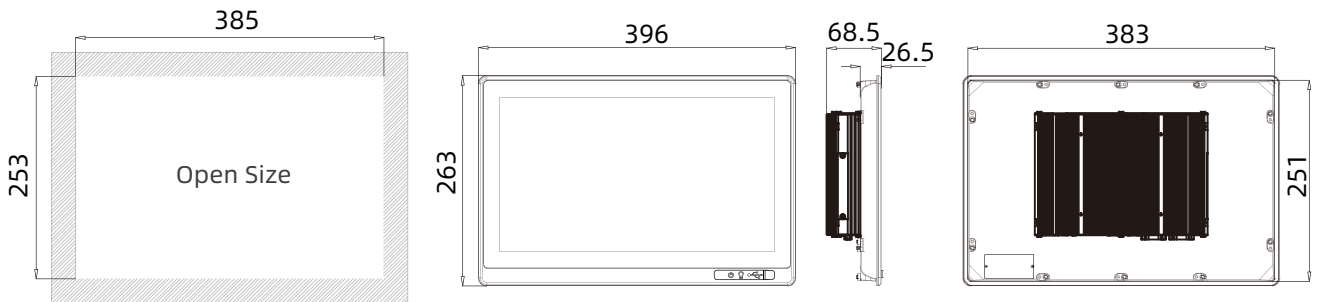

Panel Cutout Dimensions: 385 x 253mm (15.16 x 9.96in)

External I/O View

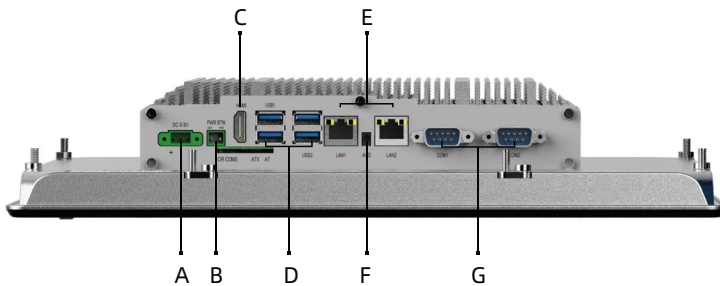

Interface definition:

- A: DC IN
- B: Power switch
- C: HDMI port
- D: 4xUSB 3.0/2.0
- E: 2xEthernet LAN
- F: Audio output
- G: 2xCOM

Ordering Information

Part Number	Description
IPC21156-3800K-4G-128G	15.6" TFT LCD / Resistive touch screen / No extension button / DC9~36V Input / Resolution 1366x768 / 3855U / 4G RAM / 128G / mSATA / 2xLAN / 4xUSB / 1xHDMI
IPC22156-3800K-4G-128G	15.6" TFT LCD / Capacitive touch screen / No extension button / DC9~36V Input / Resolution 1366x768 / 3855U / 4G RAM / 128G / mSATA / 2xLAN / 4xUSB / 1xHDMI
IPC24156-3800K-4G-128G	15.6" TFT LCD / Non-touch screen / No extension button / DC9~36V Input / Resolution 1366x768 / 3855U / 4G RAM / 128G / mSATA / 2xLAN / 4xUSB / 1xHDMI

Optional Accessories

mSATA	128G / 256G / 512G
2.5" HDD	512G / 1T / 2T
RAM	4G / 8G / 16G

Packing List

Terminal	2 pin spring clamp terminal
Terminal	3 pin screw terminals

Note: Package contents are subject to change without prior notice

Powerful. Beautiful.
Excellence · Innovation

IPC21156H
IPC22156H
IPC24156H



Shanghai Panelmate Electronics Co., Ltd.

15.6" FHD Industrial Panel PC (High resolution screen)

IPC21156H & IPC22156H & IPC24156H



Features

- Display type: 10.1",10.4",12.1",12.2",15",15.6",17",18.5",19",21.5",27"
- Front panel/back cover: Aluminium-magnesium alloy
- Large aluminium fins design to ensure the reliability and heat dissipation
- Front panel/Rear: IP65 / IP20
- Screen Type: Single point resistive touchscreen/Multi-point capacitive touchscreen/Non-touch screen
- OS:Win XP, Win7,Win10/Win11, Win CE, LINUX
- Equipped with 2xIntel i210AT Gigabit network cards, 4xUSB ports
- Processor: Intel Celeron J6412(don't support Win XP,Win 7)/3855U/3865U and Intel skylake i3/i5/i7 multiple CPU options
- Extendable WIFI/4G
- Customized LOGO

Namely Rule

IPC2XXXXHP-xxxxK-4G-128G-xxxx

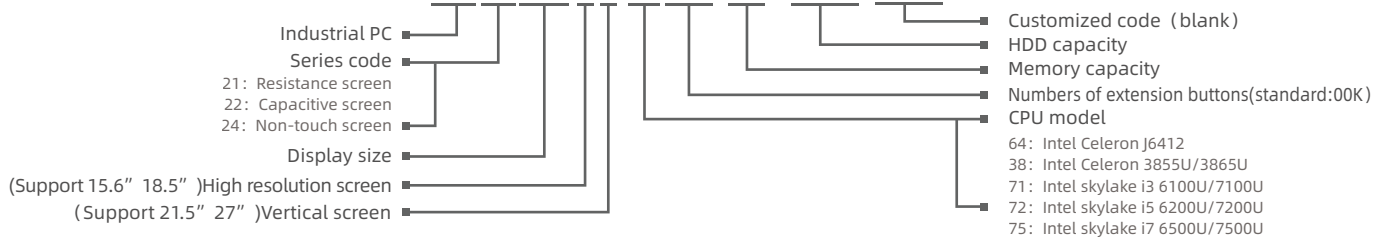

Specifications

Model	IPC21156H&IPC22156H&IPC24156H			
Processor	CPU	Intel®Celeron® processor 3855U	Intel®Apollo Lake processor J3455	Intel®Core™i5 processor
	Frequency	Dual Core 1.6GHZ	Quad Core 1.5GHZ	Dual Core 2.3GHZ
	Cache	2MB	2MB L2 Cache	3MB Intel®Smart Cache
	Memory	DDR4-2133/2400MHz,Max:16GB	1xSODIMM DDR3L 1333MHz,Max:8GB	DDR4-2133/2400MHz,Max:16GB
	Storage	1x2.5" SATA 3.0 +1 x mSATA		
I/O	Network (LAN)	2xIntel i210 1000Mbps RJ45 with surge protection		
	Audio	Realtek ALC662VD audio controller,support 5.1 channels		
	USB	4xUSB3.0/2.0		
	COM	2xRS232/RS485 with surge protection, RS485 support automatic flow control		
	Expansion Slot	1xMin-Pcie X1, Support 4G LTE/WIFI/BT with Sim card slot		
	Rear I/O	1xHDMI/2xGLAN/4xUSB/2xCOM/AUDIO/DC IN/Power Switch		
Power	Input Voltage	DC 9~36V		
	Power	33W		
Physical	Display Port	HDMI		
	Dimension (WxHxD/mm)	396 x 263 x 68.5 (15.59"x10.35"x2.70")		
	Open Size (WxH/mm)	385 x 253 (15.16"x9.96")		
	Net Weight(kg)	4.25		
	Mounting	Embedded,Wall-mounted,VESA mounting		
LCD	Display Type	15.6"FHD TFT		
	Resolution	1920 x 1080		
	Colors	16.7M		
	Active Area (WxH/mm)	344.23 x 193.54 (13.55"x7.62")		
	Backlight	LED		
	MTBF (hour)	50000hrs		
	Pixel Pitch (HxV)	0.252x0.252		
	Luminance(cd/m2)	250		
	Contrast Ratio	500:1		
	Viewing Angle	(L) 85/ (R) 85/ (U) 85/ (D) 85		
Touchscreen	Touch Type	Single point resistive touchscreen & Multi-point capacitive touchscreen & Non-touch screen		
	Light Transmission	>85%		
	Controller	USB interface		
	Driver Support	Windows7, WES7, Windows 10, Vxworks, Linux		
	Multi-touch	10 points		
	Surface Hardness	Resistive touchscreen: Mohs' Number>= 3H; Capacitive touchscreen: Mohs' Number 7H		
Environment	Operating Temperature	0~50°C		
	Storage Temperature	-20~60°C		
	Relative Humidity	5~95% (Non condensation)		
	Shock	Operating 10G peak acceleration(11 ms duration), follow IEC 60068-2-27		
	Vibration	Operating Random Vibration Test 5~500Hz, 1Grms@with HDD; 2Grms@with SSD, follow IEC 60068-2-64		
	EMC	CE/FCC Class A		
Front Panel Protection	IP65			

Technical Drawings unit:mm

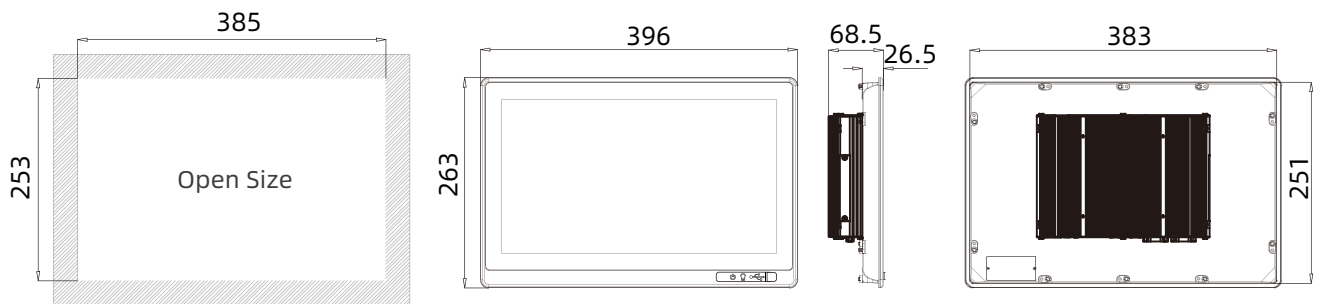

Panel Cutout Dimensions: 385 x 253mm (15.16 x 9.96in)

External I/O View

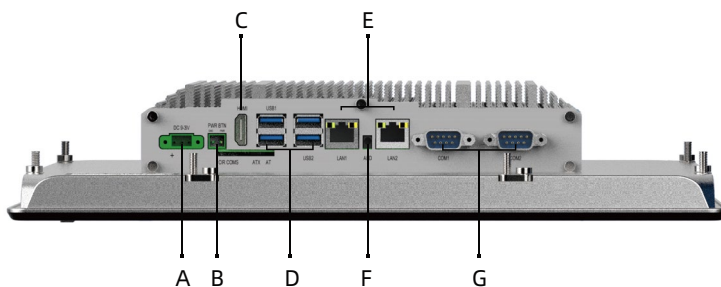

Interface definition:

- A: DC IN
- B: Power switch
- C: HDMI port
- D: 4xUSB 3.0/2.0
- E: 2xEthernet LAN
- F: Audio output
- G: 2xCOM

Ordering Information

Part Number	Description
IPC21156H-3800K-4G-128G	15.6" TFT LCD / Resistive touch screen / No extension button / DC9~36V Input / Resolution 1920x1080 / 3855U / 4G RAM / 128G / mSATA / 2xLAN / 4xUSB / 1xHDMI
IPC22156H-3800K-4G-128G	15.6" TFT LCD / Capacitive touch screen / No extension button / DC9~36V Input / Resolution 1920x1080 / 3855U / 4G RAM / 128G / mSATA / 2xLAN / 4xUSB / 1xHDMI
IPC24156H-3800K-4G-128G	15.6" TFT LCD / Non-touch screen / No extension button / DC9~36V Input / Resolution 1920x1080 / 3855U / 4G RAM / 128G / mSATA / 2xLAN / 4xUSB / 1xHDMI

Optional Accessories

mSATA	128G / 256G / 512G
2.5" HDD	512G / 1T / 2T
RAM	4G / 8G / 16G

Packing List

Terminal	2 pin spring clamp terminal
Terminal	3 pin screw terminals

Note: Package contents are subject to change without prior notice

Powerful. Beautiful.
Excellence · Innovation

IPC21170
IPC22170
IPC24170



Shanghai Panelmate Electronics Co., Ltd.

17" SXGA Industrial Panel PC

IPC21170 & IPC22170 & IPC24170



Features

- Display type: 10.1",10.4",12.1",12.2",15",15.6",17",18.5",19",21.5",27"
- Front panel/back cover: Aluminium-magnesium alloy
- Large aluminium fins design to ensure the reliability and heat dissipation
- Front panel/Rear: IP65 / IP20
- Screen Type: Single point resistive touchscreen/Multi-point capacitive touchscreen/Non-touch screen
- OS:Win XP, Win7,Win10/Win11, Win CE, LINUX
- Equipped with 2xIntel i210AT Gigabit network cards, 4xUSB ports
- Processor: Intel Celeron J6412(don't support Win XP,Win 7)/3855U/3865U and Intel skylake i3/i5/i7 multiple CPU options
- Extendable WIFI/4G
- Customized LOGO

Namely Rule

IPC2XXXXHP-xxxxK-4G-128G-xxxx

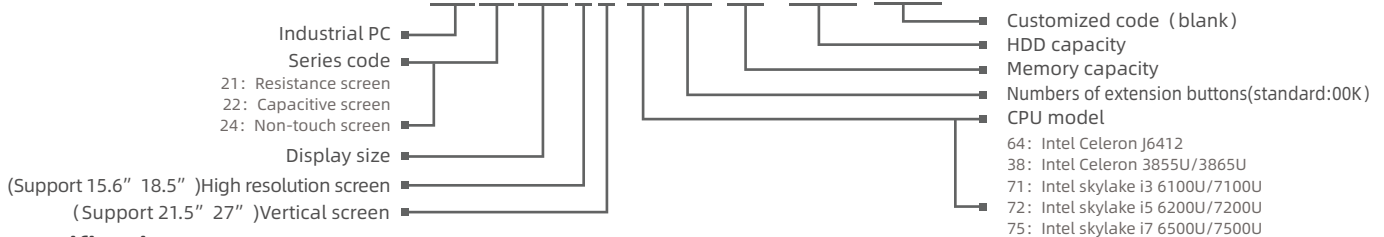

Specifications

Model	IPC21170&IPC22170&IPC24170			
Processor	CPU	Intel®Celeron® processor 3855U	Intel®Apollo Lake processor J3455	Intel®Core™i5 processor
	Frequency	Dual Core 1.6GHZ	Quad Core 1.5GHZ	Dual Core 2.3GHZ
	Cache	2MB	2MB L2 Cache	3MB Intel®Smart Cache
	Memory	DDR4-2133/2400MHZ,Max:16GB	1xSODIMM DDR3L 1333MHZ,Max:8GB	DDR4-2133/2400MHZ,Max:16GB
	Storage	1x2.5" SATA 3.0 +1 x mSATA		
I/O	Network (LAN)	2xIntel i210 1000Mbps RJ45 with surge protection		
	Audio	Realtek ALC662VD audio controller,support 5.1 channels		
	USB	4xUSB3.0/2.0		
	COM	2xRS232/RS485 with surge protection, RS485 support automatic flow control		
	Expansion Slot	1xMin-Pcle X1, Support 4G LTE/WIFI/BT with Sim card slot		
	Rear I/O	1xHDMI/2xGLAN/4xUSB/2xCOM/AUDIO/DC IN/Power Switch		
Power	Input Voltage	DC 9~36V		
	Power	37W		
Physical	Display Port	HDMI		
	Dimension (WxHxD/mm)	387 x 340 x 63.5 (15.24"x13.39"x2.5")		
	Open Size (WxH/mm)	376 x 329 (14.80"x12.95")		
	Net Weight(kg)	4.65		
	Mounting	Embedded,Wall-mounted,VESA mounting		
	LCD	Display Type	17" SXGA TFT	
Resolution		1280x1024		
Colors		16.7M		
Active Area (WxH/mm)		337.92 x 270.34 (13.30"x10.64")		
Backlight		LED		
MTBF (hour)		30000hrs		
Pixel Pitch (HxV)		0.264x0.264		
Luminance(cd/m2)		250		
Contrast Ratio		1000:1		
Viewing Angle		(L) 88/ (R) 88/ (U) 85/ (D) 85		
Touchscreen	Touch Type	Single point resistive touchscreen & Multi-point capacitive touchscreen& Non-touch screen		
	Light Transmission	>85%		
	Controller	USB interface		
	Driver Support	Windows7, WES7, Windows 10, Vxworks, Linux		
	Multi-touch	10 points		
	Surface Hardness	Resistive touchscreen: Mohs' Number>= 3H; Capacitive touchscreen: Mohs' Number 7H		
Environment	Operating Temperature	0~50°C		
	Storage Temperature	-20~60°C		
	Relative Humidity	5~95% (Non condensation)		
	Shock	Operating 10G peak acceleration(11 ms duration), follow IEC 60068-2-27		
	Vibration	Operating Random Vibration Test 5~500Hz, 1Grms@with HDD; 2Grms@with SSD, follow IEC 60068-2-64		
	EMC	CE/FCC Class A		
Front Panel Protection	IP65			

IPC21170 & IPC22170 & IPC24170

Technical Drawings unit:mm

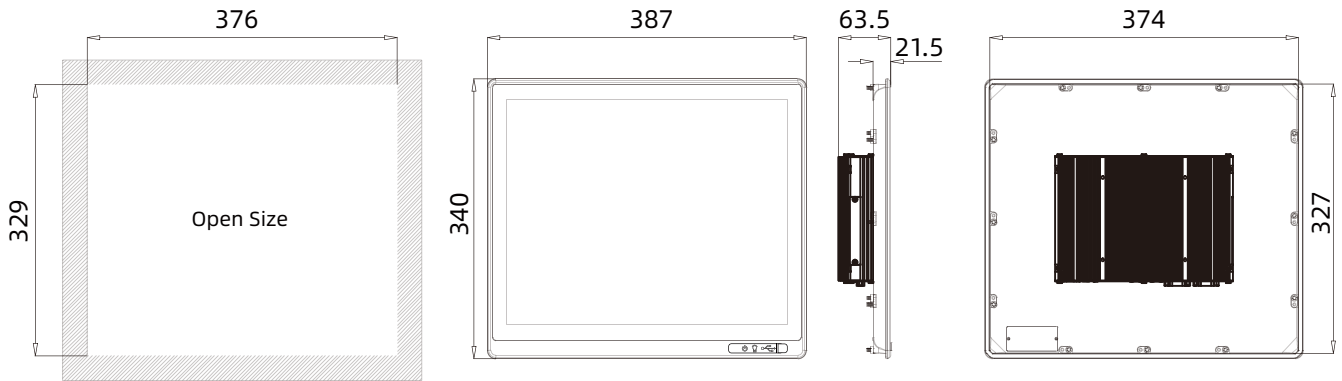

Panel Cutout Dimensions: 376 x 329mm (14.80 x 12.95in)

External I/O View

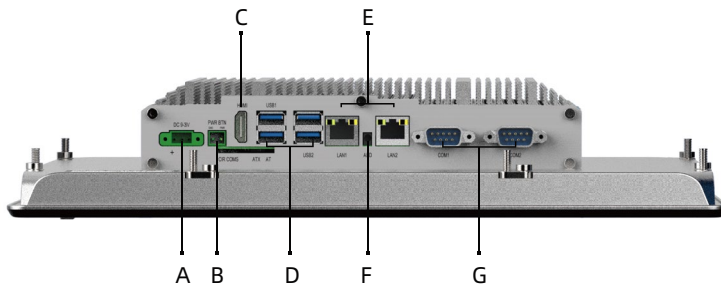

Interface definition:

- A: DC IN
- B: Power switch
- C: HDMI port
- D: 4xUSB 3.0/2.0
- E: 2xEthernet LAN
- F: Audio output
- G: 2xCOM

Ordering Information

Part Number	Description
IPC21170-3800K-4G-128G	17" TFT LCD / Resistive touch screen / No extension button / DC9~36V Input / Resolution 1280x1024 / 3855U / 4G RAM / 128G / mSATA / 2xLAN / 4xUSB / 1xHDMI
IPC22170-3800K-4G-128G	17" TFT LCD / Capacitive touch screen / No extension button / DC9~36V Input / Resolution 1280x1024 / 3855U / 4G RAM / 128G / mSATA / 2xLAN / 4xUSB / 1xHDMI
IPC24170-3800K-4G-128G	17" TFT LCD / Non-touch screen / No extension button / DC9~36V Input / Resolution 1280x1024 / 3855U / 4G RAM / 128G / mSATA / 2xLAN / 4xUSB / 1xHDMI

Optional Accessories

mSATA	128G / 256G / 512G
2.5" HDD	512G / 1T / 2T
RAM	4G / 8G / 16G

Packing List

Terminal	2 pin spring clamp terminal
Terminal	3 pin screw terminals

Note: Package contents are subject to change without prior notice

Powerful. Beautiful.
Excellence · Innovation

IPC21185
IPC22185
IPC24185



Shanghai Panelmate Electronics Co., Ltd.

18.5" WXGA Industrial Panel PC

IPC21185 & IPC22185 & IPC24185



Features

- Display type: 10.1",10.4",12.1",12.2",15",15.6",17",18.5",19",21.5",27"
- Front panel/back cover: Aluminium-magnesium alloy
- Large aluminium fins design to ensure the reliability and heat dissipation
- Front panel/Rear: IP65 / IP20
- Screen Type: Single point resistive touchscreen/Multi-point capacitive touchscreen/Non-touch screen
- OS:Win XP, Win7,Win10/Win11, Win CE, LINUX
- Equipped with 2xIntel i210AT Gigabit network cards, 4xUSB ports
- Processor: Intel Celeron J6412(don't support Win XP,Win 7)/3855U/3865U and Intel skylake i3/i5/i7 multiple CPU options
- Extendable WIFI/4G
- Customized LOGO

Namely Rule

IPC2XXXXHP-xxxxK-4G-128G-xxxx

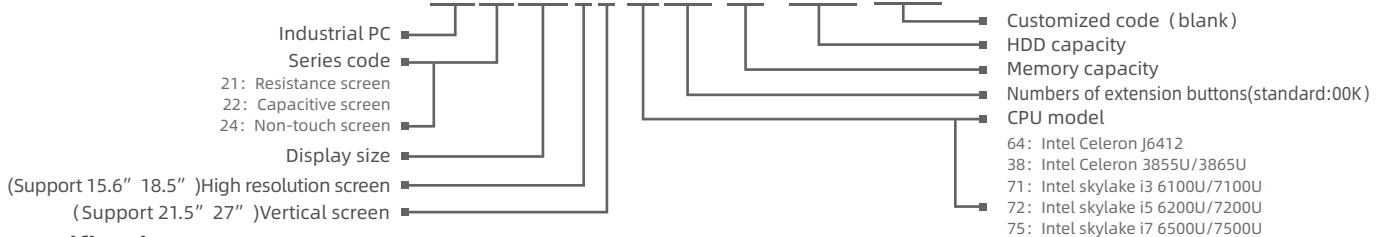

Specifications

Model	IPC21185&IPC22185&IPC24185			
Processor	CPU	Intel®Celeron® processor 3855U	Intel®Apollo Lake processor J3455	Intel®Core™i5 processor
	Frequency	Dual Core 1.6GHZ	Quad Core 1.5GHZ	Dual Core 2.3GHZ
	Cache	2MB	2MB L2 Cache	3MB Intel®Smart Cache
	Memory	DDR4-2133/2400MHz,Max:16GB	1xSODIMM DDR3L 1333MHZ,Max:8GB	DDR4-2133/2400MHz,Max:16GB
	Storage	1x2.5" SATA 3.0 +1 x mSATA		
I/O	Network (LAN)	2xIntel i210 1000Mbps RJ45 with surge protection		
	Audio	Realtek ALC662VD audio controller,support 5.1 channels		
	USB	4xUSB3.0/2.0		
	COM	2xRS232/RS485 with surge protection, RS485 support automatic flow control		
	Expansion Slot	1xMin-Pcie X1, Support 4G LTE/WIFI/BT with Sim card slot		
	Rear I/O	1xHDMI/2xGLAN/4xUSB/2xCOM/AUDIO/DC IN/Power Switch		
Power	Input Voltage	DC 9~36V		
	Power	41W		
Physical	Display Port	HDMI		
	Dimension (WxHxD/mm)	463 x 304 x 63.5 (18.23"x11.93"x2.5")		
	Open Size (WxH/mm)	452 x 292 (17.80"x11.50")		
	Net Weight(kg)	4.8		
	Mounting	Embedded,Wall-mounted,VESA mounting		
LCD	Display Type	18.5" WXGA TFT		
	Resolution	1366x768		
	Colors	16.7M		
	Active Area (WxH/mm)	409.8 x 230.4 (16.13"x9.07")		
	Backlight	LED		
	MTBF (hour)	30000hrs		
	Pixel Pitch (HxV)	0.3x0.3		
	Luminance(cd/m2)	500		
	Contrast Ratio	1000:1		
Viewing Angle	(L) 89/ (R) 89/ (U) 89/ (D) 89			
Touchscreen	Touch Type	Single point resistive touchscreen & Multi-point capacitive touchscreen & Non-touch screen		
	Light Transmision	>85%		
	Controller	USB interface		
	Driver Support	Windows7, WES7, Windows 10, Vxworks, Linux		
	Multi-touch	10 points		
	Surface Hardness	Resistive touchscreen: Mohs' Number>= 3H; Capacitive touchscreen: Mohs' Number 7H		
Environment	Operating Temperature	0~50°C		
	Storage Temperature	-20~60°C		
	Relative Humidity	5~95% (Non condensation)		
	Shock	Operating 10G peak acceleration(11 ms duration), follow IEC 60068-2-27		
	Vibration	Operating Random Vibration Test 5~500Hz, 1Grms@with HDD; 2Grms@with SSD, follow IEC 60068-2-64		
	EMC	CE/FCC Class A		
	Front Panel Protection	IP65		

Technical Drawings unit:mm

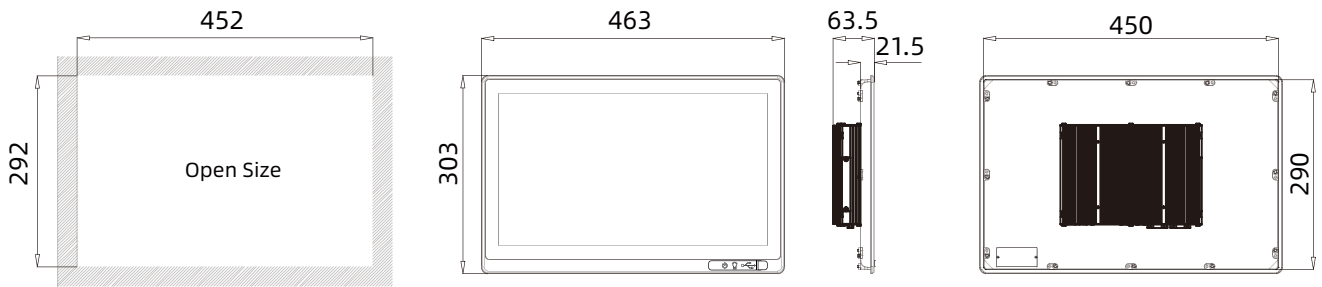

Panel Cutout Dimensions: 452x 292mm (17.80 x 11.50in)

External I/O View

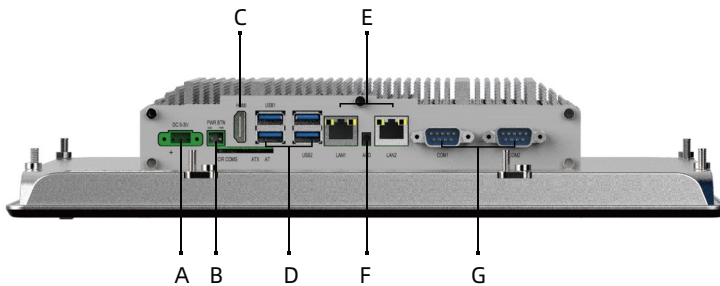

Interface definition:

- A: DC IN
- B: Power switch
- C: HDMI port
- D: 4xUSB 3.0/2.0
- E: 2xEthernet LAN
- F: Audio output
- G: 2xCOM

Ordering Information

Part Number	Description
IPC21185-3800K-4G-128G	18.5" TFT LCD / Resistive touch screen / No extension button / DC9~36V Input / Resolution 1366x768 / 3855U / 4G RAM / 128G / mSATA / 2xLAN / 4xUSB / 1xHDMI
IPC22185-3800K-4G-128G	18.5" TFT LCD / Capacitive touch screen / No extension button / DC9~36V Input / Resolution 1366x768 / 3855U / 4G RAM / 128G / mSATA / 2xLAN / 4xUSB / 1xHDMI
IPC24185-3800K-4G-128G	18.5" TFT LCD / Non-touch screen / No extension button / DC9~36V Input / Resolution 1366x768 / 3855U / 4G RAM / 128G / mSATA / 2xLAN / 4xUSB / 1xHDMI

Optional Accessories

mSATA	128G / 256G / 512G
2.5" HDD	512G / 1T / 2T
RAM	4G / 8G / 16G

Packing List

Terminal	2 pin spring clamp terminal
Terminal	3 pin screw terminals

Note: Package contents are subject to change without prior notice

Powerful. Beautiful.
Excellence · Innovation

IPC21185H
IPC22185H
IPC24185H



Shanghai Panelmate Electronics Co., Ltd.

18.5" FHD Industrial Panel PC (High resolution screen)

IPC21185H & IPC22185H & IPC24185H

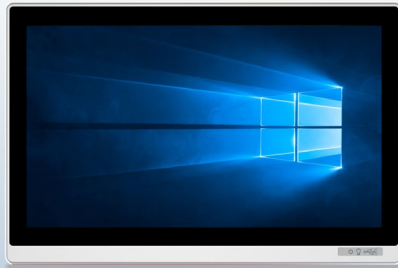

Features

- Display type: 10.1",10.4",12.1",12.2",15",15.6",17",18.5",19",21.5",27"
- Front panel/back cover: Aluminium-magnesium alloy
- Large aluminium fins design to ensure the reliability and heat dissipation
- Front panel/Rear: IP65 / IP20
- Screen Type: Single point resistive touchscreen/Multi-point capacitive touchscreen/Non-touch screen
- OS:Win XP, Win7,Win10/Win11, Win CE, LINUX
- Equipped with 2xIntel i210AT Gigabit network cards, 4xUSB ports
- Processor: Intel Celeron J6412(don't support Win XP,Win 7)/3855U/3865U and Intel skylake i3/i5/i7 multiple CPU options
- Extendable WIFI /4G
- Customized LOGO

Namely Rule

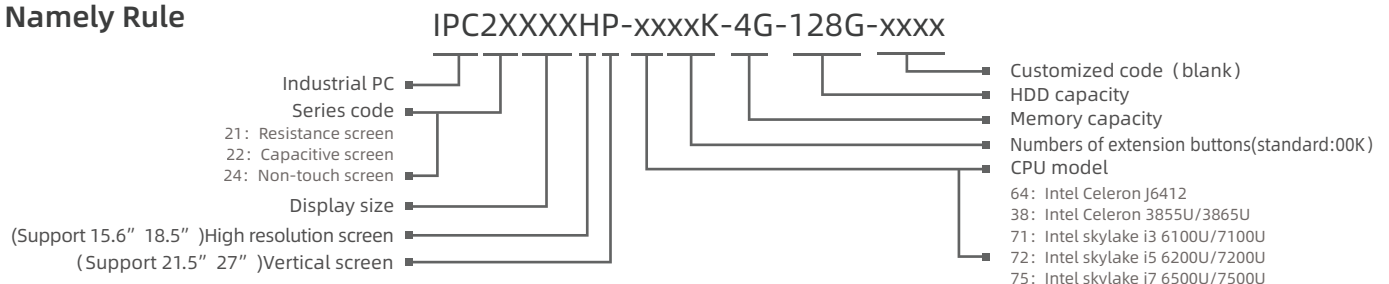

Specifications

Model	IPC21185H&IPC22185H&IPC24185H			
Processor	CPU	Intel®Celeron® processor 3855U	Intel®Apollo Lake processor J3455	Intel®Core™i5 processor
	Frequency	Dual Core 1.6GHZ	Quad Core 1.5GHZ	Dual Core 2.3GHZ
	Cache	2MB	2MB L2 Cache	3MB Intel®Smart Cache
	Memory	DDR4-2133/2400MHz,Max:16GB	1xSODIMM DDR3L 1333MHZ,Max:8GB	DDR4-2133/2400MHz,Max:16GB
	Storage	1x2.5" SATA 3.0 +1 x mSATA		
I/O	Network (LAN)	2xIntel i210 1000Mbps RJ45 with surge protection		
	Audio	Realtek ALC662VD audio controller,support 5.1 channels		
	USB	4xUSB3.0/2.0		
	COM	2xRS232/RS485 with surge protection, RS485 support automatic flow control		
	Expansion Slot	1xMin-Pcie X1, Support 4G LTE/WIFI/BT with Sim card slot		
	Rear I/O	1xHDMI/2xGLAN/4xUSB/2xCOM/AUDIO/DC IN/Power Switch		
Power	Input Voltage	DC 9~36V		
	Power	40W		
Physical	Display Port	HDMI		
	Dimension (WxHxD/mm)	463 x 304 x 63.5 (18.23"x11.93"x2.5")		
	Open Size (WxH/mm)	452 x 292 (17.80"x11.50")		
	Net Weight(kg)	4.8		
	Mounting	Embedded,Wall-mounted,VESA mounting		
LED	Display Type	18.5"FHD TFT		
	Resolution	1920 x 1080		
	Colors	16.7M		
	Active Area (WxH/mm)	409.8 x 230.4 (16.13"x9.07")		
	Backlight	LED		
	MTBF (hour)	30000hrs		
	Pixel Pitch (HxV)	0.3x0.3		
	Luminance(cd/m2)	350		
	Contrast Ratio	1000:1		
	Viewing Angle	(L) 89/ (R) 89/ (U) 89/ (D) 89		
Touchscreen	Touch Type	Single point resistive touchscreen & Multi-point capacitive touchscreen & Non-touch screen		
	Light Transmission	>85%		
	Controllor	USB interface		
	Driver Support	Windows7, WES7, Windows 10, Vxworks, Linux		
	Multi-touch	10 points		
	Surface Hardness	Resistive touchscreen: Mohs' Number>= 3H; Capacitive touchscreen: Mohs' Number 7H		
Environment	Operating Temperature	-20~80°C		
	Storage Temperature	-20~80°C		
	Relative Humidity	5~95% (Non condensation)		
	Shock	Operating 10G peak acceleration(11 ms duration), follow IEC 60068-2-27		
	Vibration	Operating Random Vibration Test 5~500Hz, 1Grms@with HDD; 2Grms@with SSD, follow IEC 60068-2-64		
	EMC	CE/FCC Class A		
	Front Panel Protection	IP65		

Technical Drawings unit:mm

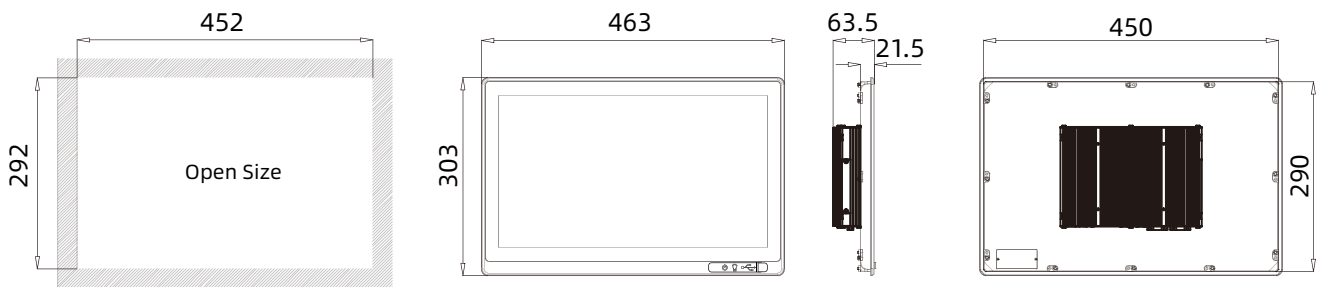

Panel Cutout Dimensions: 452x 292mm (17.80 x 11.50in)

External I/O View

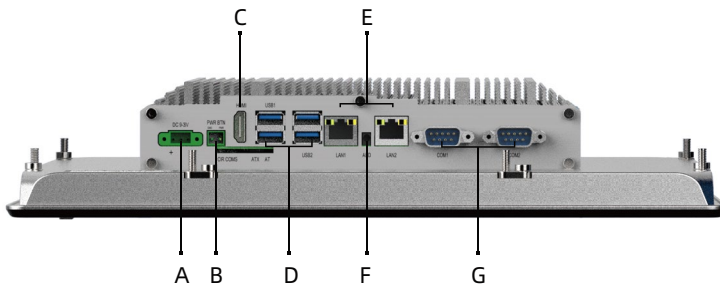

Interface definition:

- A: DC IN
- B: Power switch
- C: HDMI port
- D: 4xUSB 3.0/2.0
- E: 2xEthernet LAN
- F: Audio output
- G: 2xCOM

Ordering Information

Part Number	Description
IPC21185H-3800K-4G-128G	18.5" TFT LCD / Resistive touch screen / No extension button / DC9~36V Input / Resolution 1920x1080 / 3855U / 4G RAM / 128G / mSATA / 2xLAN / 4xUSB / 1xHDMI
IPC22185H-3800K-4G-128G	18.5" TFT LCD / Capacitive touch screen / No extension button / DC9~36V Input / Resolution 1920x1080 / 3855U / 4G RAM / 128G / mSATA / 2xLAN / 4xUSB / 1xHDMI
IPC24185H-3800K-4G-128G	18.5" TFT LCD / Non-touch screen / No extension button / DC9~36V Input / Resolution 1920x1080 / 3855U / 4G RAM / 128G / mSATA / 2xLAN / 4xUSB / 1xHDMI

Optional Accessories

mSATA	128G / 256G / 512G
2.5" HDD	512G / 1T / 2T
RAM	4G / 8G / 16G

Packing List

Terminal	2 pin spring clamp terminal
Terminal	3 pin screw terminals

Note: Package contents are subject to change without prior notice

Powerful. Beautiful.

Excellence · Innovation

IPC21190

IPC22190

IPC24190



Shanghai Panelmate Electronics Co., Ltd.

19" SXGA Industrial Panel PC

IPC21190 & IPC22190 & IPC24190



Features

- Display type: 10.1",10.4",12.1",12.2",15",15.6",17",18.5",19",21.5",27"
- Front panel/back cover: Aluminium-magnesium alloy
- Large aluminium fins design to ensure the reliability and heat dissipation
- Front panel/Rear: IP65 / IP20
- Screen Type: Single point resistive touchscreen/Multi-point capacitive touchscreen/Non-touch screen
- OS:Win XP, Win7,Win10/Win11, Win CE, LINUX
- Equipped with 2xIntel i210AT Gigabit network cards, 4xUSB ports
- Processor: Intel Celeron J6412(don't support Win XP,Win 7)/3855U/3865U and Intel skylake i3/i5/i7 multiple CPU options
- Extensible WIFI , 4G network
- Customized LOGO

Namely Rule

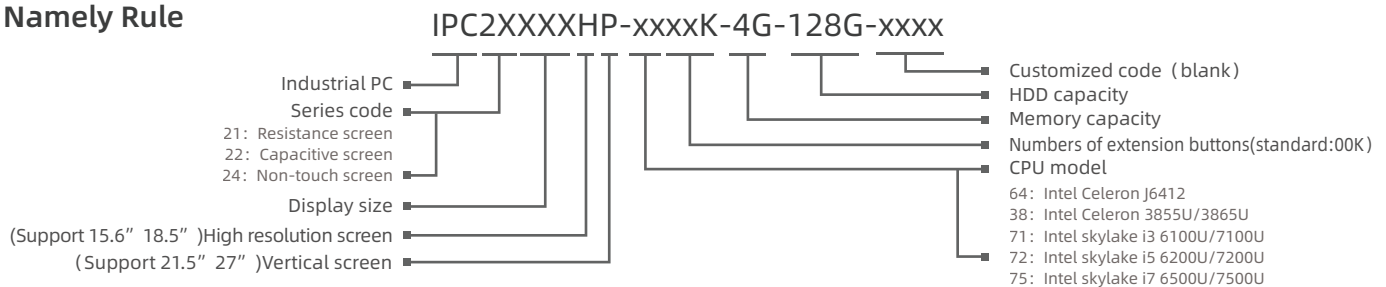

Specifications

Model	IPC21190&IPC22190&IPC24190			
Processor	CPU	Intel®Celeron® processor 3855U	Intel®Apollo Lake processor J3455	Intel®Core™i5 processor
	Frequency	Dual Core 1.6GHZ	Quad Core 1.5GHZ	Dual Core 2.3GHZ
	Cache	2MB	2MB L2 Cache	3MB Intel®Smart Cache
	Memory	DDR4-2133/2400MHZ,Max:16GB	1xSODIMM DDR3L 1333MHZ,Max:8GB	DDR4-2133/2400MHZ,Max:16GB
	Storage	1x2.5" SATA 3.0 +1 x mSATA		
I/O	Network (LAN)	2xIntel i210 1000Mbps RJ45 with surge protection		
	Audio	Realtek ALC662VD audio controller,support 5.1 channels		
	USB	4xUSB3.0/2.0		
	COM	2xRS232/RS485 with surge protection, RS485 support automatic flow control		
	Expansion Slot	1xMin-Pcie X1, Support 4G LTE/WIFI/BT with Sim card slot		
	Rear I/O	1xHDMI/2xGLAN/4xUSB/2xCOM/AUDIO/DC IN/Power Switch		
Power	Input Voltage	DC 9~36V		
	Power	39W		
Physical	Display Port	HDMI		
	Dimension (WxHxD/mm)	428 x 372 x 63.5 (16.85"x14.65"x2.5")		
	Open Size (WxH/mm)	412 x 358 (16.22"x14.09)		
	Net Weight(kg)	5.45		
	Mounting	Embedded,Wall-mounted,VESA mounting		
	LCD	Display Type	19" SXGA TFT	
Resolution		1280x1024		
Colors		16.7M		
Active Area (WxH/mm)		376.32 x 301.06 (14.82"x11.85")		
Backlight		LED		
MTBF (hour)		30000hrs		
Pixel Pitch (HxV)		0.294x0.294		
Luminance(cd/m2)		250		
Contrast Ratio		1000:1		
Viewing Angle		(L) 85/ (R) 85/ (U) 80/ (D) 80		
Touchscreen	Touch Type	Single point resistive touchscreen & Multi-point capacitive touchscreen & Non-touch screen		
	Light Transmission	>85%		
	Controller	USB interface		
	Driver Support	Windows7, WES7, Windows 10, Vxworks, Linux		
	Multi-touch	10 points		
	Surface Hardness	Resistive touchscreen: Mohs' Number>= 3H; Capacitive touchscreen: Mohs' Number 7H		
Environment	Operating Temperature	0~50°C		
	Storage Temperature	-20~60°C		
	Relative Humidity	5~95% (Non condensation)		
	Shock	Operating 10G peak acceleration(11 ms duration), follow IEC 60068-2-27		
	Vibration	Operating Random Vibration Test 5~500Hz, 1Grms@with HDD; 2Grms@with SSD, follow IEC 60068-2-64		
	EMC	CE/FCC Class A		
	Front Panel Protection	IP65		

Technical Drawings unit:mm

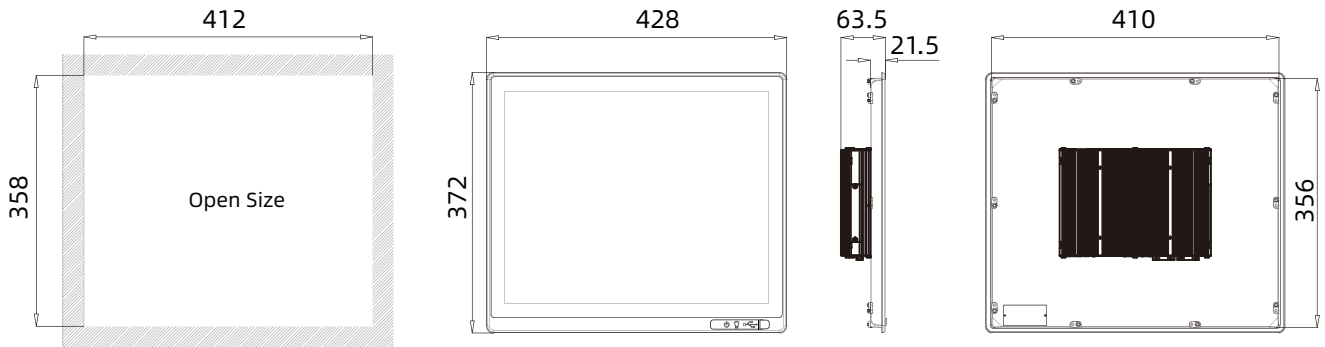

Panel Cutout Dimensions: 412 x 358mm (16.22 x 14.09in)

External I/O View

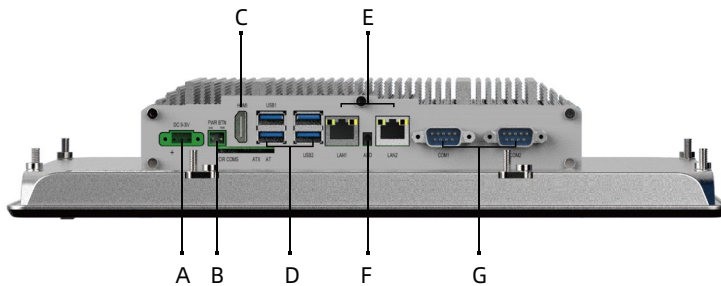

Interface definition:

- A: DC IN
- B: Power switch
- C: HDMI port
- D: 4xUSB 3.0/2.0
- E: 2xEthernet LAN
- F: Audio output
- G: 2xCOM

Ordering Information

Part Number	Description
IPC21190-3800K-4G-128G	19" TFT LCD / Resistive touch screen / No extension button / DC9~36V Input / Resolution 1280x1024 / 3855U / 4G RAM / 128G / mSATA / 2xLAN / 4xUSB / 1xHDMI
IPC22190-3800K-4G-128G	19" TFT LCD / Capacitive touch screen / No extension button / DC9~36V Input / Resolution 1280x1024 / 3855U / 4G RAM / 128G / mSATA / 2xLAN / 4xUSB / 1xHDMI
IPC24190-3800K-4G-128G	19" TFT LCD / Non-touch screen / No extension button / DC9~36V Input / Resolution 1280x1024 / 3855U / 4G RAM / 128G / mSATA / 2xLAN / 4xUSB / 1xHDMI

Optional Accessories

mSATA	128G / 256G / 512G
2.5" HDD	512G / 1T / 2T
RAM	4G / 8G / 16G

Packing List

Terminal	2 pin spring clamp terminal
Terminal	3 pin screw terminals

Note: Package contents are subject to change without prior notice

Powerful. Beautiful.

Excellence · Innovation

IPC21215 (P)

IPC22215 (P)

IPC24215 (P)

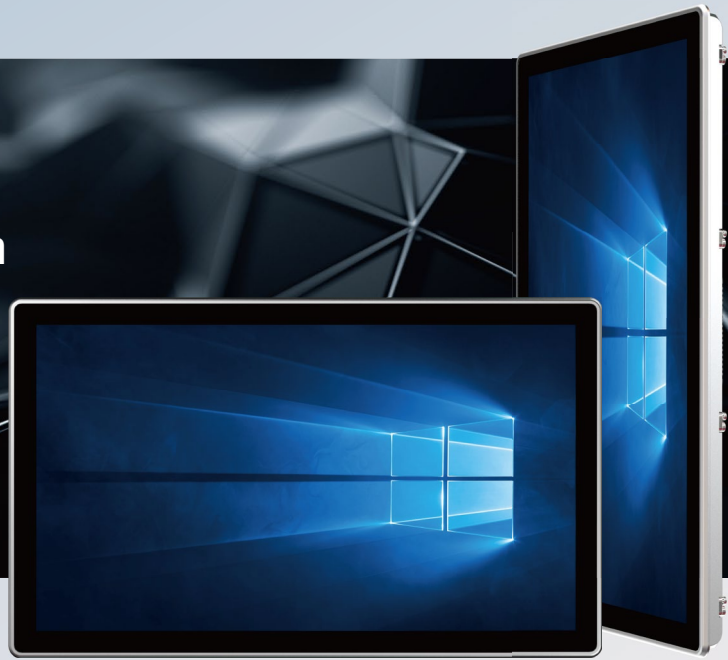

Shanghai Panelmate Electronics Co., Ltd.

21.5" FHD Industrial Panel PC (Vertical Screen)

IPC21215 (P) & IPC22215 (P) & IPC24215 (P)



Features

- Display type: 10.1",10.4",12.1",12.2",15",15.6",17",18.5",19",21.5",27"
- Front panel/back cover: Aluminium-magnesium alloy
- Large aluminium fins design to ensure the reliability and heat dissipation
- Front panel/Rear: IP65 / IP20
- Screen Type: Single point resistive touchscreen/Multi-point capacitive touchscreen/Non-touch screen
- OS:Win XP, Win7,Win10/Win11, Win CE, LINUX
- Equipped with 2xIntel i210AT Gigabit network cards, 4xUSB ports
- Processor: Intel Celeron J6412(don't support Win XP,Win 7)/3855U/3865U and Intel skylake i3/i5/i7 multiple CPU options
- Extendable WIFI/4G
- Customized LOGO

Namely Rule

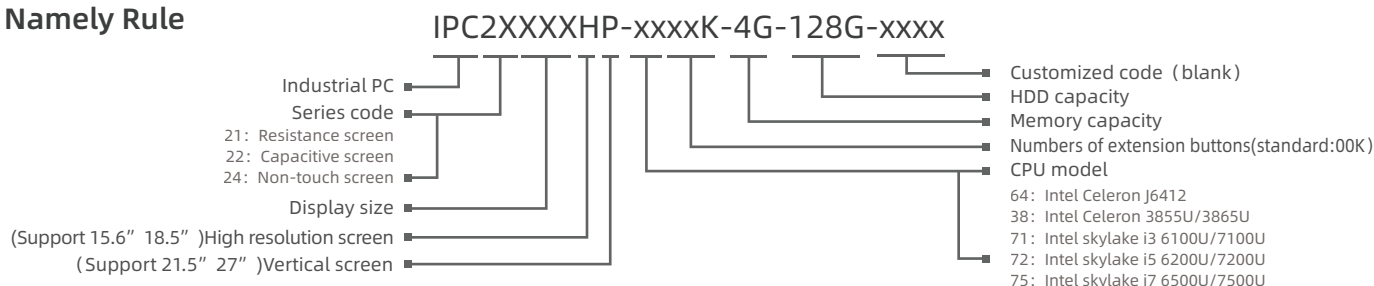

Specifications

Model	IPC21215 (P) & IPC22215 (P) & IPC24215 (P)			
Processor	CPU	Intel®Celeron® processor 3855U	Intel®Apollo Lake processor J3455	Intel®Core™i5 processor
	Frequency	Dual Core 1.6GHZ	Quad Core 1.5GHZ	Dual Core 2.3GHZ
	Cache	2MB	2MB L2 Cache	3MB Intel®Smart Cache
	Memory	DDR4-2133/2400MHz,Max:16GB	1xSODIMM DDR3L 1333MHZ,Max:8GB	DDR4-2133/2400MHz,Max:16GB
	Storage	1x2.5" SATA 3.0 +1 x mSATA		
I/O	Network (LAN)	2xIntel i210 1000Mbps RJ45 with surge protection		
	Audio	Realtek ALC662VD audio controller,support 5.1 channels		
	USB	4xUSB3.0/2.0		
	COM	2xRS232/RS485 with surge protection , RS485 support automatic flow control		
	Expansion Slot	1xMin-Pcie X1 , Support 4G LTE/WIFI/BT with Sim card slot		
Power	Input Voltage	DC 9~36V		
	Power	45W		
Physical	Display Port	HDMI		
	Dimension (WxHxD/mm)	530.5 x 322.5 x 63.5 (20.89"x12.70"x2.5")		
	Open Size (WxH/mm)	519 x 311 (20.43"x12.24")		
	Net Weight(kg)	5.5		
	Mounting	Embedded,Wall-mounted,VESA mounting		
LCD	Display Type	21.5" FHD TFT		
	Resolution	1920x1080		
	Colors	16.7M		
	Active Area (WxH/mm)	476.64 x 268.11 (18.77"x10.56")		
	Backlight	LED		
	MTBF (hour)	30000hrs		
	Pixel Pitch (HxV)	0.24825x0.24825		
	Luminance(cd/m2)	250		
	Contrast Ratio	3000:1		
Viewing Angle	(L) 89/ (R) 89/ (U) 89/ (D) 89			
Touchscreen	Touch Type	Single point resistive touchscreen & Multi-point capacitive touchscreen& Non-touch screen		
	Light Transmission	>85%		
	Controller	USB interface		
	Driver Support	Windows7, WES7, Windows 10, Vxworks, Linux		
	Multi-touch	10 points		
	Surface Hardness	Resistive touchscreen: Mohs' Number>= 3H; Capacitive touchscreen: Mohs' Number 7H		
Environment	Operating Temperature	0~50°C		
	Storage Temperature	-20~60°C		
	Relative Humidity	5~95% (Non condensation)		
	Shock	Operating 10G peak acceleration(11 ms duration), follow IEC 60068-2-27		
	Vibration	Operating Random Vibration Test 5~500Hz, 1Grms@with HDD; 2Grms@with SSD, follow IEC 60068-2-64		
	EMC	CE/FCC Class A		
Front Panel Protection	IP65			

Technical Drawings unit:mm

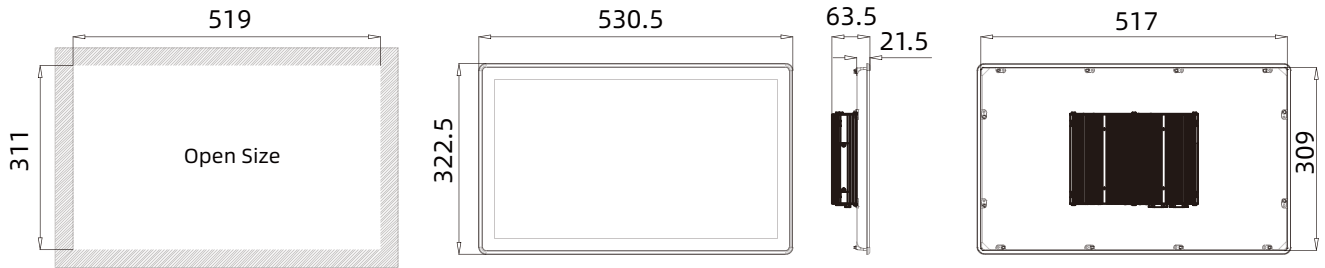

Panel Cutout Dimensions: 519x 311mm (20.43 x 12.24in)

External I/O View

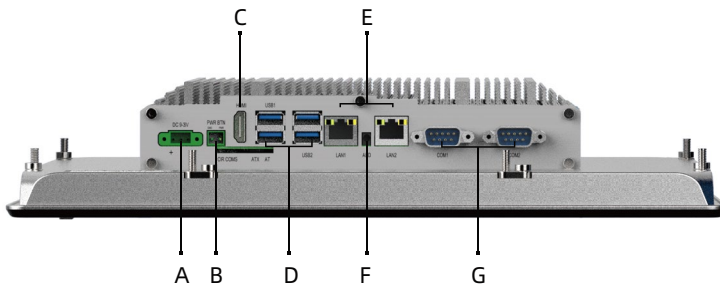

Interface definition:

- A: DC IN
- B: Power switch
- C: HDMI port
- D: 4xUSB 3.0/2.0
- E: 2xEthernet LAN
- F: Audio output
- G: 2xCOM

Ordering Information

Part Number	Description
IPC21215 (P) -3800K-4G-128G	21.5" TFT LCD / Resistive touch screen / No extension button / DC9~36V Input / Resolution 1920x1080 / 3855U / 4G RAM / 128G / mSATA / 2xLAN / 4xUSB / 1xHDMI
IPC22215 (P) -3800K-4G-128G	21.5" TFT LCD / Capacitive touch screen / No extension button / DC9~36V Input / Resolution 1920x1080 / 3855U / 4G RAM / 128G / mSATA / 2xLAN / 4xUSB / 1xHDMI
IPC24215 (P) -3800K-4G-128G	21.5" TFT LCD / Non-touch screen / No extension button / DC9~36V Input / Resolution 1920x1080 / 3855U / 4G RAM / 128G / mSATA / 2xLAN / 4xUSB / 1xHDMI

Optional Accessories

mSATA	128G / 256G / 512G
2.5" HDD	512G / 1T / 2T
RAM	4G / 8G / 16G

Packing List

Terminal	2 pin spring clamp terminal
Terminal	3 pin screw terminals

Note: Package contents are subject to change without prior notice

Powerful. Beautiful.

Excellence · Innovation

IPC22240 (P)

IPC24240 (P)



Shanghai Panelmate Electronics Co., Ltd.

24" FHD Industrial Panel PC (Vertical Screen)

IPC22240 (P) & IPC24240 (P)

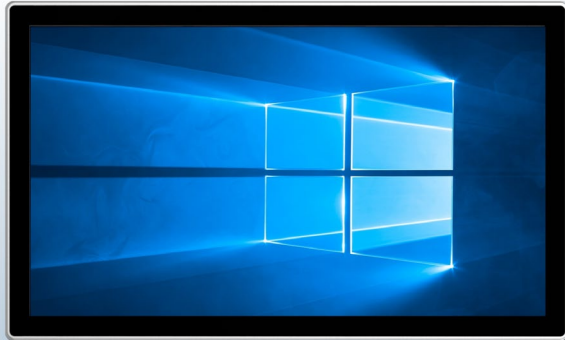

Features

- Display type: 10.1",10.4",12.1",12.2",15",15.6",17",18.5",19",21.5",24",27"
- Front panel/back cover: Aluminium-magnesium alloy
- Large aluminium fins design to ensure the reliability and heat dissipation
- Front panel/Rear: IP65 / IP20
- Screen Type: Multi-point capacitive touchscreen / Non-touch screen
- OS:Win XP, Win7,Win10/Win11, Win CE, LINUX
- Equipped with 2xIntel i210AT Gigabit network cards, 4xUSB ports
- Processor: Intel Celeron J6412(don't support Win XP,Win 7)/3855U/3865U and Intel skylake i3/i5/i7 multiple CPU options
- Extendable WIFI/4G
- Customized LOGO

Namely Rule

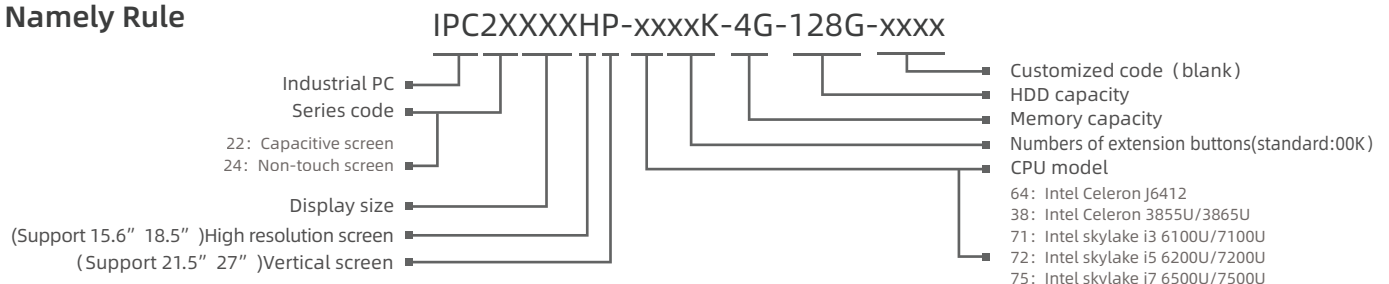

Specifications

Model	IPC22240 (P) & IPC24240 (P)	
Processor	CPU	Intel®Apollo Lake processor J3455
	Frequency	Quad Core 1.5GHZ
	Cache	2MB L2 Cache
	Memory	1xSODIMM DDR3L 1333MHZ,Max: 8GB
	Storage	1x2.5" SATA HDD +1 x mSATA
I/O	Network (LAN)	2xIntel i210 1000Mbps RJ45 with surge protection
	Audio	Realtek ALC662VD audio controller,support 5.1 channels
	USB	4xUSB3.0/2.0
	COM	2xRS232/RS485 with surge protection, RS485 support automatic flow control
	Expansion Slot	1xMin-Pcie X1, Support 4G LTE/WIFI/BT with Sim card slot
	Rear I/O	1xHDMI/2xGLAN/4xUSB/2xCOM/AUDIO/DC IN/Power Switch
Power	Input Voltage	DC 9~36V
	Power	50W
Physical	Display Port	HDMI
	Dimension (WxHxD/mm)	581.4 x 348.6 x 60 (22.89" x 13.72" x 2.36")
	Open Size (WxH/mm)	567 x 334 (22.32" x 13.15")
	Net Weight(kg)	6.5
	Mounting	Embedded,Wall-mounted,VESA mounting
LCD	Display Type	24" FHD TFT
	Resolution	1920x1080
	Colors	16.7M
	Active Area (WxH/mm)	527.04 x296.46 (20.75" x 16.67")
	Backlight	LED
	MTBF (hour)	30000hrs
	Pixel Pitch (HxV)	0.2745 x 0.2745
	Luminance(cd/m2)	250
	Contrast Ratio	3000:1
	Viewing Angle	(L)89 / (R)89 / (U)89 / (D)89
Touchscreen	Touch Type	Multi-point capacitive touchscreen & Non-touch screen
	Light Transmission	>85%
	Controller	USB interface
	Driver Support	Windows7, WES7, Windows 10, Vxworks, Linux
	Multi-touch	10 points
	Surface Hardness	Capacitive touchscreen: Mohs' Number 7H
Environment	Operating Temperature	0~50°C
	Storage Temperature	-20~60°C
	Relative Humidity	5~95% (Non condensation)
	Shock	Operating 10G peak acceleration(11 ms duration), follow IEC 60068-2-27
	Vibration	Operating Random Vibration Test 5~500Hz, 1Grms@with HDD; 2Grms@with SSD, follow IEC 60068-2-64
	EMC	CE/FCC Class A
Front Panel Protection	IP65	

IPC22240 (P) & IPC24240 (P)

Technical Drawings unit:mm

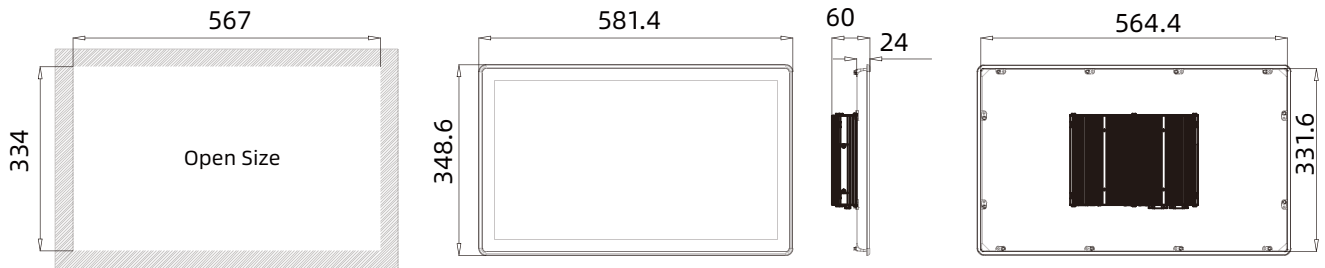

Panel Cutout Dimensions: 567 x 334mm (22.32 x 13.15in)

External I/O View

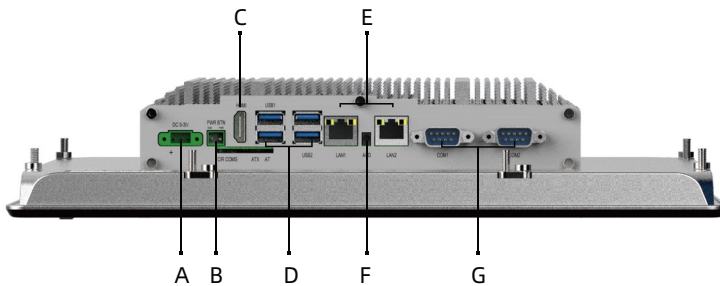

Interface definition:

- A: DC IN
- B: Power switch
- C: HDMI port
- D: 4xUSB 3.0/2.0
- E: 2xEthernet LAN
- F: Audio output
- G: 2xCOM

Ordering Information

Part Number	Description
IPC22240 (P) -3800K-4G-128G	24" TFT LCD / Capacitive touch screen / No extension button / DC9~36V Input / Resolution 1920x1080 / 3855U / 4G RAM / 128G / mSATA / 2xLAN / 4xUSB / 1xHDMI
IPC24240 (P) -3800K-4G-128G	24" TFT LCD / Non-touch screen / No extension button / DC9~36V Input / Resolution 1920x1080 / 3855U / 4G RAM / 128G / mSATA / 2xLAN / 4xUSB / 1xHDMI

Optional Accessories

mSATA	128G / 256G / 512G
2.5" HDD	512G / 1T / 2T
RAM	4G / 8G / 16G

Packing List

Terminal	2 pin spring clamp terminal
Terminal	3 pin screw terminals

Note: Package contents are subject to change without prior notice

Powerful. Beautiful.

Excellence · Innovation

IPC22270 (P)

IPC24270 (P)



Shanghai Panelmate Electronics Co., Ltd.

27" FHD Industrial Panel PC (Vertical Screen)

IPC22270 (P) & IPC24270 (P)

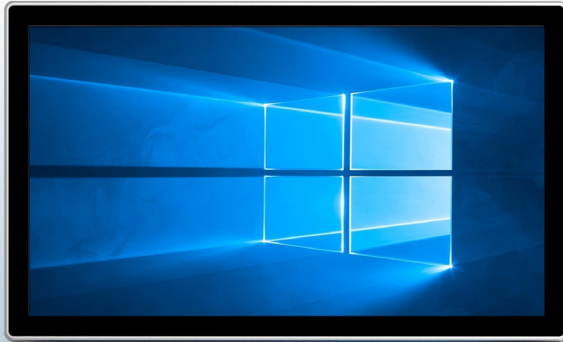

Features

- Display type: 10.1",10.4",12.1",12.2",15",15.6",17",18.5",19",21.5",27"
- Front panel/back cover: Aluminium-magnesium alloy
- Large aluminium fins design to ensure the reliability and heat dissipation
- Front panel/Rear: IP65 / IP20
- Screen Type: Multi-point capacitive touchscreen / Non-touch screen
- OS:Win XP, Win7,Win10/Win11, Win CE, LINUX
- Equipped with 2xIntel i210AT Gigabit network cards, 4xUSB ports
- Processor: Intel Celeron J6412(don't support Win XP,Win 7)/3855U/3865U and Intel skylake i3/i5/i7 multiple CPU options
- Extendable WIFI/4G
- Customized LOGO

Namely Rule

IPC2XXXXHP-xxxxK-4G-128G-xxxx

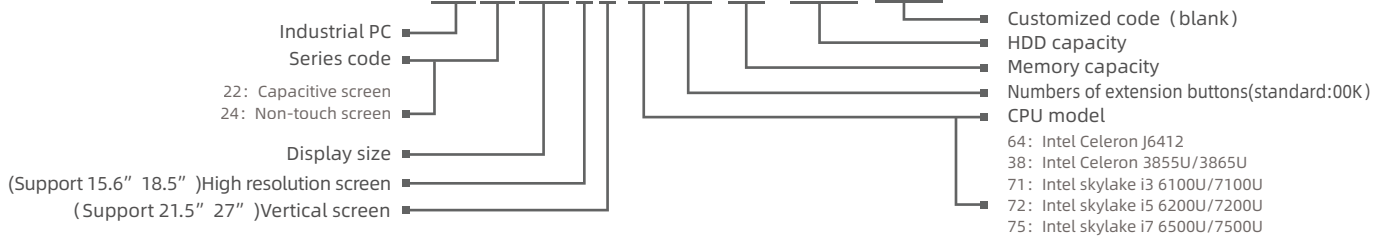

Specifications

Model	IPC22270 (P) & IPC24270 (P)		
Processor	CPU	Intel®Apollo Lake processor J3455	Intel®Core™i5 processor
	Frequency	Quad Core 1.5GHZ	Dual Core 2.5GHZ
	Cache	2MB L2 Cache	3MB Intel®Smart Cache
	Memory	1xSODIMM DDR3L 1333MHZ,Max: 8GB	DDR4-2133/2400MHZ,Max: 16GB
	Storage	1x2.5" SATA HDD +1 x mSATA	
I/O	Network (LAN)	2xIntel i210 1000Mbps RJ45 with surge protection	
	Audio	Realtek ALC662VD audio controller,support 5.1 channels	
	USB	4xUSB3.0/2.0	
	COM	2xRS232/RS485 with surge protection, RS485 support automatic flow control	
	Expansion Slot	1xMin-Pcie X1, Support 4G LTE/WIFI/BT with Sim card slot	
	Rear I/O	1xHDMI/2xGLAN/4xUSB/2xCOM/AUDIO/DC IN/Power Switch	
Power	Input Voltage	DC 9~36V	
	Power	61W	
Physical	Display Port	HDMI	
	Dimension (WxHxD/mm)	395.5 x 656.6 x 66 (15.57"x25.85"x2.60")	
	Open Size (WxH/mm)	380.5 x 641.5 (14.98"x25.26")	
	Net Weight(kg)	8.55	
	Mounting	Embedded,Wall-mounted,VESA mounting	
LCD	Display Type	27" FHD TFT	
	Resolution	1920x1080	
	Colors	16.7M	
	Active Area (WxH/mm)	598 x 336 (23.54"x13.23")	
	Backlight	LED	
	MTBF (hour)	30000hrs	
	Pixel Pitch (HxV)	0.24825x0.24825	
	Luminance(cd/m2)	250	
	Contrast Ratio	3000:1	
	Viewing Angle	(L) 89/ (R) 89/ (U) 89/ (D) 89	
Touchscreen	Touch Type	Multi-point capacitive touchscreen & Non-touch screen	
	Light Transmission	>85%	
	Controller	USB interface	
	Driver Support	Windows7, WES7, Windows 10, Vxworks, Linux	
	Multi-touch	10 points	
	Surface Hardness	Resistive touchscreen: Mohs' Number>= 3H; Capacitive touchscreen: Mohs' Number 7H	
Environment	Operating Temperature	0~50°C	
	Storage Temperature	-20~60°C	
	Relative Humidity	5~95% (Non condensation)	
	Shock	Operating 10G peak acceleration(11 ms duration), follow IEC 60068-2-27	
	Vibration	Operating Random Vibration Test 5~500Hz, 1Grms@with HDD; 2Grms@with SSD, follow IEC 60068-2-64	
	EMC	CE/FCC Class A	
	Front Panel Protection	IP65	

IPC22270 (P) & IPC24270 (P)

Technical Drawings unit:mm

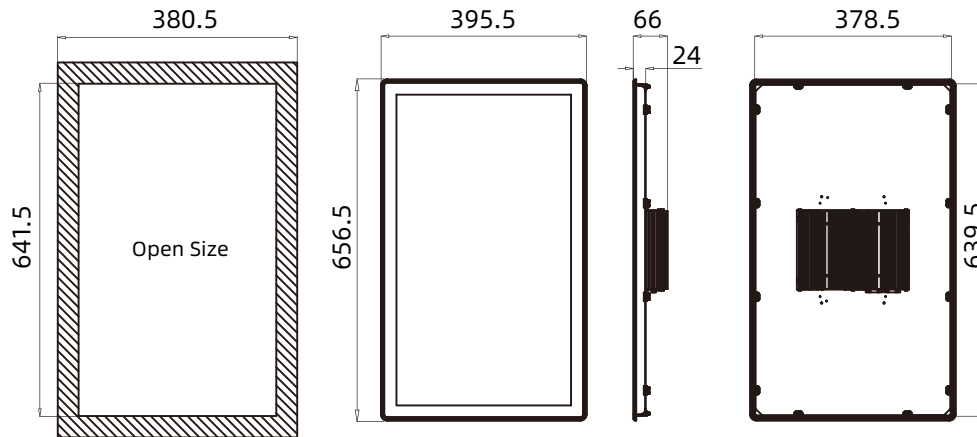

Panel Cutout Dimensions: 380.5 x 641.5mm (14.98 x 25.26in)

External I/O View

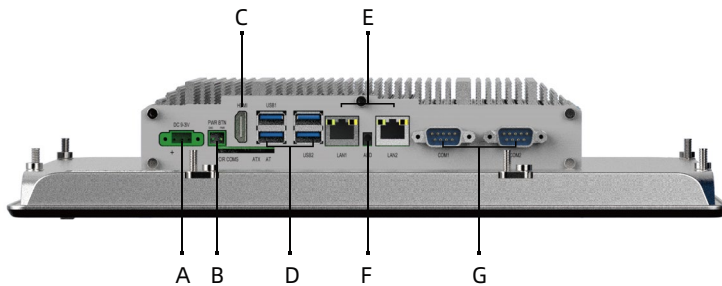

Interface definition:

- A: DC IN
- B: Power switch
- C: HDMI port
- D: 4xUSB 3.0/2.0
- E: 2xEthernet LAN
- F: Audio output
- G: 2xCOM

Ordering Information

Part Number	Description
IPC22270 (P) -3800K-4G-128G	27" TFT LCD / Capacitive touch screen / No extension button / DC9~36V Input / Resolution 1920x1080 / 3855U / 4G RAM / 128G / mSATA / 2xLAN / 4xUSB / 1xHDMI
IPC24270 (P) -3800K-4G-128G	27" TFT LCD / Non-touch screen / No extension button / DC9~36V Input / Resolution 1920x1080 / 3855U / 4G RAM / 128G / mSATA / 2xLAN / 4xUSB / 1xHDMI

Optional Accessories

mSATA	128G / 256G / 512G
2.5" HDD	512G / 1T / 2T
RAM	4G / 8G / 16G

Packing List

Terminal	2 pin spring clamp terminal
Terminal	3 pin screw terminals

Note: Package contents are subject to change without prior notice