

Powerful. Beautiful.

Excellence · Innovation

IDD21121

IDD22121

IDD24121



Shanghai Panelmate Electronics Co., Ltd.

12.1" XGA Industrial Monitor

PANELMATE
Creative HMI Solution

IDD21121 & IDD22121 & IDD24121



Features

- Display type: 10.1",10.4",11.6",12.1",12.2",15",15.6",17",17.3",18.5",19", 21.5",24",27"
- Front panel/back cover: Aluminium-magnesium alloy
- IP: Front panel IP65 / Rear cover IP20
- Screen Type: Single point resistive touchscreen, Multi-point capacitive touchscreen, Non-touch screen
- OS:Win7, Win8, Win10, Win11, Linux, etc
- Interface: DVI, HDMI, VGA video interface, 2xUSB
- DC 12~36V
- R1(IDD-LINK),Long distance USB signal output, support 50m
- R2(IDD-LINK4),Video and USB are transmitted via a single CAT6 network cable, Transmission distance up to 100m

Namely Rule

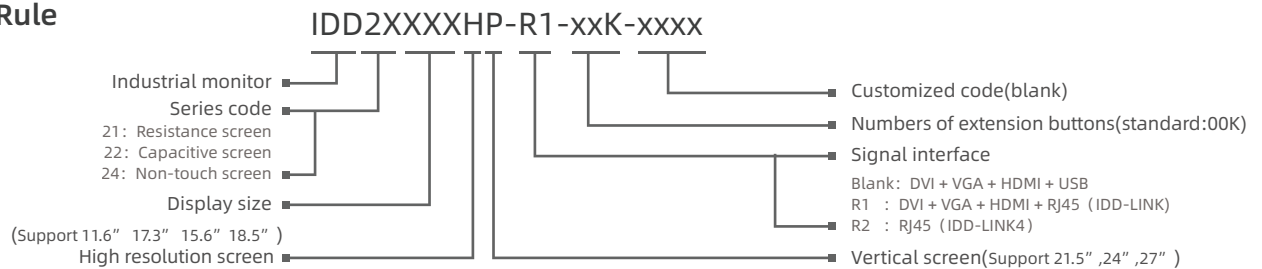

Specifications

Model	IDD21121&IDD22121&IDD24121	
Routine	Control button	Set contrast ratio and luminance via OSD at the back cover
	Housing	Front panel & back cover:Aluminium-magnesium alloy,Grounding isolation protection
	Mounting	Embedded,Wall-mounted,VESA ,Desktop
	Rear I/O	VGA & DVI & HDMI & USB
Power	Input Voltage	DC 9~36V
	Power	9W
Physical	Dimension (WxHxD/mm)	306 x 259 x 57.5 (12.05" x 10.20" x 2.26")
	Open Size (WxH/mm)	295 x 248 (11.61" x 9.76")
	Net Weight(kg)	2.7
LCD	Display type	12.1" XGA TFT
	Resolution	1024 x 768
	Colors	16.7M
	Active Area (WxH/mm)	304.1 x 228.1 (11.97" x 8.98")
	Backlight	LED
	MTBF(Hour)	50000hrs
	Pixel Pitch (HxV)	0.24 x 0.24
	Luminance(cd/m2)	350
	Contrast Ratio	800:1
	Viewing Angle	(L)75 / (R)75 / (U)75 / (D)75
Touchscreen	Touch Type	Single point resistive touchscreen & Multi-point capacitive touchscreen & Non-touch screen
	Light Transmission	>85%
	Controller	USB interface
	Driver Support	Windows7, Window8, Windows10, Windows11, Linux, etc
	Multi-touch	10 points
	Surface Hardness	Resistive touchscreen: Mohs' Number >= 3H;Capacitive touchscreen: Mohs' Number 7H
Environment	Operating Temperature	-20 ~ 70°C
	Storage Temperature	-30 ~ 80°C
	Relative Humidity	5 ~ 95% (Non condensation)
	Shock	Operating 10G peak acceleration(11 ms duration), follow IEC 60068-2-27
	Vibration	Operating Random Vibration Test 5~500Hz,1Grms@with HDD;2Grms@with SSD, follow IEC 60068-2-64
	EMC	CE/FCC Class A
	Front Panel Protection	Front panel IP65 compliant

Technical Drawings unit:mm

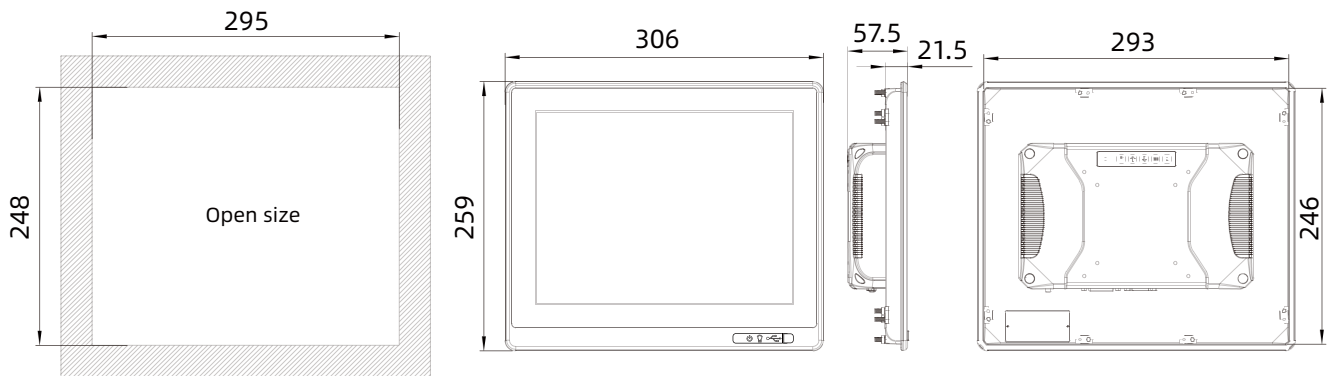

Panel Cutout Dimensions: 295 x 248mm (11.61 x 9.76in)

External I/O View

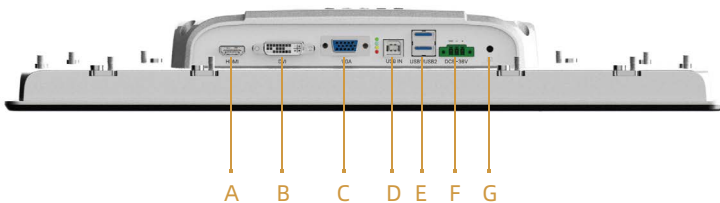

Interface definition:

- A: HDMI
- B: DVI
- C: VGA
- D: USB input
- E: USB output
- F: DC 9~36V
- G: GND

Ordering Information

Part Number	Description
IDD21121	12.1" TFT LCD / Resistive touch screen / DC9~36V DC9~36V Input / Resolution 1024x768
IDD22121	12.1" TFT LCD / Capacitive touch screen / DC9~36V Input / Resolution 1024x768
IDD24121	12.1" TFT LCD / Non-touch screen / DC9~36V Input / Resolution 1024x768

Optional Accessories

VGA	VGA 3m / 5m
DVI	DVI 3m / 5m / 8m / 10m
USB	USB 3m / 5m / 10m
HDMI	HDMI 3m / 5m / 10m

Packing List

Terminals	3pin spring clamp terminal
-----------	----------------------------

Note: Package contents are subject to change without prior notice