

Powerful. Beautiful.

Excellence · Innovation

PC6970-4RJ



Shanghai Panelmate Electronics Co., Ltd.

PC6970 Wall-mounted Box PC (Extended 4 net ports)



Features

- Compact aluminum-magnesium alloy profile housing, dust-proof design
- Intel® Core™ 6/7/8/9th i3/i5/i7, Intel® Pentium® high performance desktop processor optional
- Unilateral interface, DIN rail wall-mounted
- 2 x Intel i210 Gbe LAN support EtherCAT and jumbo frames
- 4 x USB3.0, built-in 1 x USB2.0, pluggable software dongle to prevent data loss
- DVI+DP dual interface
- 2 x COM (DB9) , 2 x COM (DB9) , BIOS serial port setting RS232 or RS485
- OS: Win7, Win8, Win10, Win11, Linux ,etc (Intel®Core™ 8/9th don't support Win7)
- Real-time optimization, more suitable for motion control
- DC 9~36V

Namely Rule

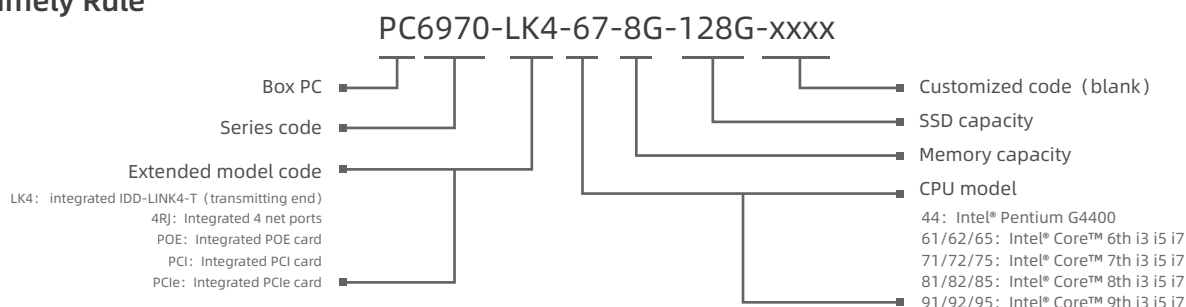

Specifications

Model	PC6970-4RJ		
Processor	CPU	Intel® Pentium® G4400 , Intel® Core™ 6/7/8/9th i3 i5 i7	
	Chipset	Intel® H110	
	BIOS	AMI UEFI 64Mbit	
	Storage	1x2.5" SATA 3.0 HDD/SDD, 1x full size mSATA (SATA & USB2.0)	
	Memory	DDR4-2133/2400MHz, Preinstallation 4GB, Max: 32GB	
I/O	LAN	2 x Intel i210-AT 1000Mbps RJ45 with surge protection	
	USB	4xUSB3.0, built-in 1xUSB2.0 (hardware USB softdog)	
	COM	2xRS232/RS422/RS485, interface is isolated from TVS (DB9), RS485 supports automatic flow control	
	Expansion Slot	1xmini-PCIe (PCIe+USB) with SIM card slot, scalable 4G, LTE, BT, ETC	
	Pilot Lamp	1x Power light	
	Input Voltage	DC 9~36V , 2x2 pin terminal	
	Wachdog	0-255 programmable setting	
	Control Switch	1x power switch	
	Display Type		DP Max-resolution: 4096*2304@60Hz
			DVI-I (DVI-D+VGA): DVI-D: resolution: 1920*1200@60Hz
		VGA: resolution: 2560*1600@60Hz	
OS	OS	Windows7, Window8, Windows10, Windows11, Linux, etc (Intel®Core™ 8/9th don't support Win7)	
Physical	Dimension (WxHxD)	202mm x 152mm x 70.8mm (7.95" x 5.98" x 2.79")	
	Box Structure	Compacted aluminium-magnesium alloy profile housing, seal and dust-proof design, GND protection	
	Mounting	Wall-mounted, DIN-Rail mounting	
	Power	120W	
	Net Weight	2.15kg	
Environment	Operating Temperature	-20~60°C	
	Storage Temperature	-40~80°C	
	Relative Humidity	5~95% (Non condensation)	
	Shock	Operating 10G peak acceleration(11 ms duration), follow IEC 60068-2-27	
	Vibration	Operating Random Vibration Test 5~500Hz, 1Grms@with HDD; 2Grms@with SSD, follow IEC 60068-2-64	
	EMC	CE/FCC Class A	

Technical Drawings unit: mm

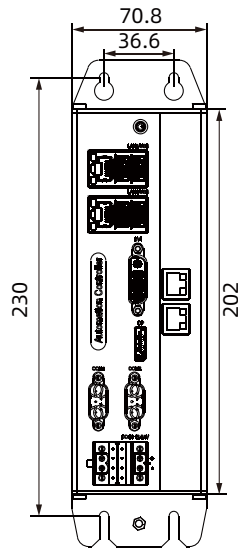

Front view

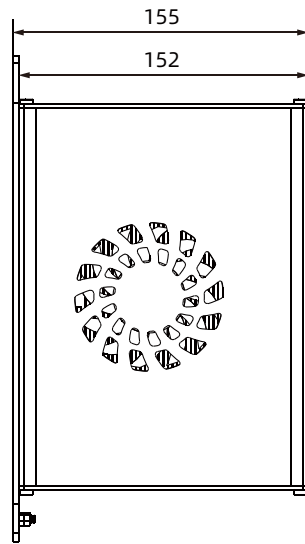

Side view

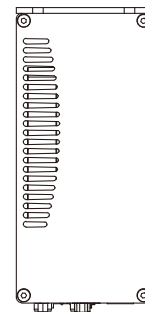

Top view

External I/O View

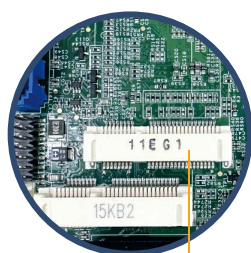
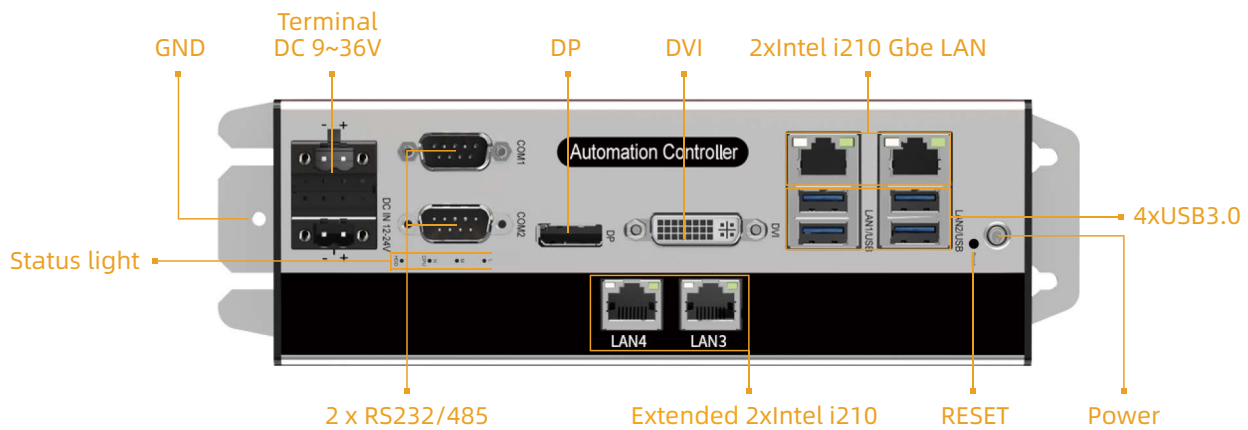

miniPCIe Expansion slot



builtin USB2.0 Softdog

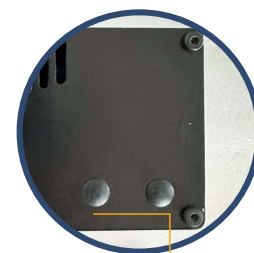

2 x Wireless antenna

Ordering Information

Part Number	Description
PC6970-4RJ	CPU:Null, RAM: Null, mSATA: Null; 2xCOM (RS232/485 by BIOS switchable) , 4 x LAN, 4 x USB3.0, DVI-I/DP display interface, DC 9~36V power input
PC6970-4RJ-44-4G-128G	CPU:Intel® Pentium® G4400, RAM: 4G, mSATA: 128G; 2xCOM (RS232/485 by BIOS switchable) , 4 x LAN, 4 x USB3.0, DVI-I/DP display interface, DC 9~36V power input
PC6970-4RJ-61-4G-128G	CPU:Intel® Core™ 6th i3, RAM: 4G, mSATA: 128G; 2xCOM (RS232/485 by BIOS switchable) , 4 x LAN, 4 x USB3.0, DVI-I/DP display interface, DC 9~36V power input
PC6970-4RJ-62-4G-128G	CPU:Intel® Core™ 6th i5, RAM: 4G, mSATA: 128G; 2xCOM (RS232/485 by BIOS switchable) , 4 x LAN, 4 x USB3.0, DVI-I/DP display interface, DC 9~36V power input
PC6970-4RJ-65-4G-128G	CPU:Intel® Core™ 6th i7, RAM: 4G, mSATA: 128G; 2xCOM (RS232/485 by BIOS switchable) , 4 x LAN, 4 x USB3.0, DVI-I/DP display interface, DC 9~36V power input
PC6970-4RJ-71-4G-128G	CPU:Intel® Core™ 7th i3, RAM: 4G, mSATA: 128G; 2xCOM (RS232/485 by BIOS switchable) , 4 x LAN, 4 x USB3.0, DVI-I/DP display interface, DC 9~36V power input
PC6970-4RJ-72-4G-128G	CPU:Intel® Core™ 7th i5, RAM: 4G, mSATA: 128G; 2xCOM (RS232/485 by BIOS switchable) , 4 x LAN, 4 x USB3.0, DVI-I/DP display interface, DC 9~36V power input
PC6970-4RJ-75-4G-128G	CPU:Intel® Core™ 7th i7, RAM: 4G, mSATA: 128G; 2xCOM (RS232/485 by BIOS switchable) , 4 x LAN, 4 x USB3.0, DVI-I/DP display interface, DC 9~36V power input

Optional Accessories

Optional Accessories	Description	
CPU	Intel® Pentium	G4400
	Intel® Core™ 6th	i3, i5, i7
	Intel® Core™ 7th	i3, i5, i7
	Intel® Core™ 8th	i3, i5, i7
	Intel® Core™ 9th	i3, i5, i7
DDR4 memory	DDR4-2400MHz, 4GB, 8GB, 16GB, 32GB	
SSD	mSATA, 64GB, 128GB, 256GB, 512GB, 1TB	
WIFI set	miniPCIe, WIFI sets, (7260HMWBN) wireless antenna	
4G/EC203G module	miniPCIe	