

Powerful. Beautiful.

Excellence · Innovation

TP2-R2



Shanghai Panelmate Electronics Co., Ltd.

10.1" WXGA Teach Pendant (with IDD-LINK4)



Features

- 10.1" teach pendant for handling robots, resolution 1280x800
- IP: IP54
- Ergonomic design, comfortable and easy to operate
- The button in the lower right corner of the GUI for quick access to custom functions
- Moderate display size, shoulder straps and grips are designed to simplify operation and prevent fatigue
- System frame grounding protection (GPE) design
- Optional R2 (IDD-LINK4), Video and USB are transmitted via a single CAT6 network cable up to 100 meters
- OS: Win7, Win8, Win10, Win11, Linux, etc
- DC 24V

Namely Rule

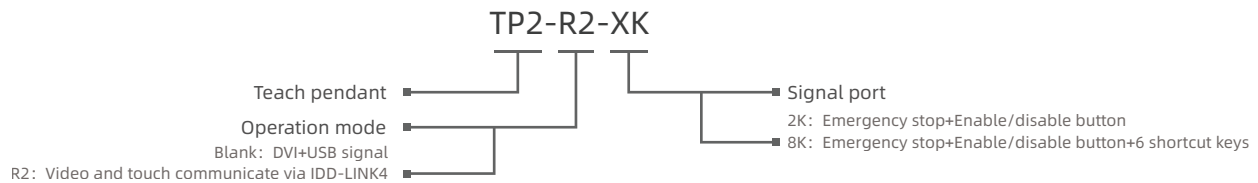

Specifications

Model	TP2-R2	
Routine	Housing	Front panel: aluminium magnesium alloy ; Rear cover: ABS+PC
	Interface	Emergency stop+24V+3-digit Enable button+IDD-LINK4 signal+18P button signal
Power	Input Voltage	DC 24V
	Power	15W
Physical	Dimension (WxHxD)	279mm x 228.6mm x 80.6mm (10.98" x 9" x 3.17")
	Net Weight	1.4kg
LCD	Display Type	10.1" WXGA TFT
	Resolution	1280 x 800
	Colors	16.7M
	Active Area (WxH)	216.96mm x 135.60mm (8.54" x 5.34")
	Backlight	LED
	MTBF (hour)	30000hrs
	Pixel Pitch (HxV)	0.1695 x 0.1695
	Luminance(cd/ m2)	400cd / m2
	Contrast Ratio	800:1
Viewing Angle	(L)85 / (R)85 / (U)85 / (D)85	
Touchscreen	Touch Type	Multi-point capacitive touchscreen
	Light Transmission	>85%
	Controller	USB interface
	Driver Support	Windows7, Window8, Windows10, Windows11, Linux, etc
	Multi-touch	10 points
Surface Hardness	Capacitive touchscreen: Mohs' Number 7H	
Environment	Operating Temperature	-20~70°C
	Storage Temperature	-30~70°C
	Relative Humidity	5~95% (Non condensation)
	Shock	Operating 10G peak acceleration(11 ms duration), follow IEC 60068-2-27
	Vibration	Operating Random Vibration Test 5~500Hz, 1Grms@with HDD;2Grms@with SSD, follow IEC 60068-2-64
	EMC	CE/FCC Class A
Protection level	IP54	

TP2-R2

Technical Drawings unit: mm

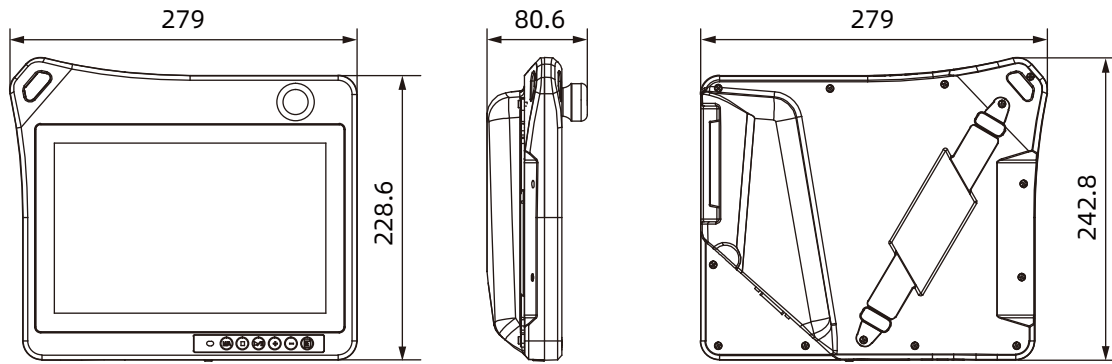

TP2 teach pendant size

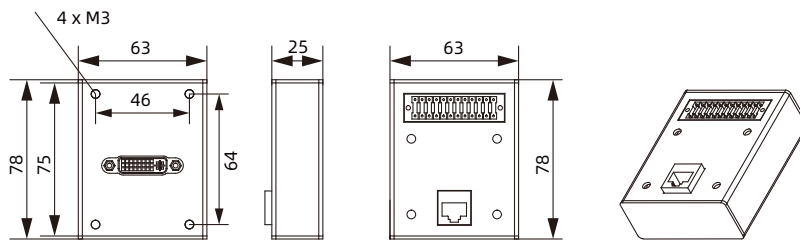

TP2-R2-JB wiring box size

External I/O View

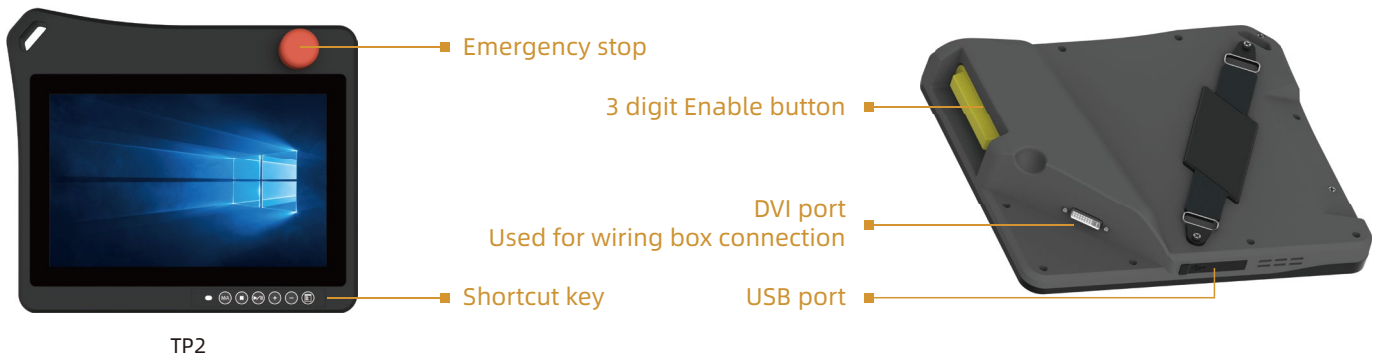

TP2

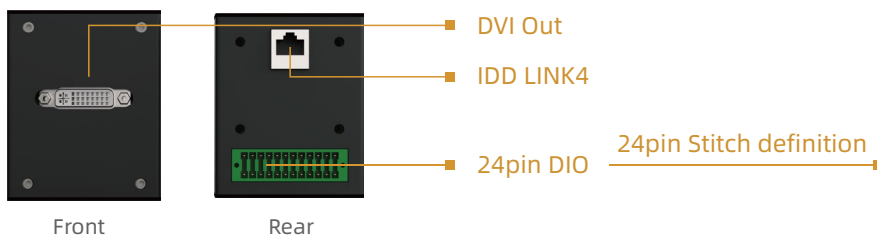

Front

Rear

TP2-R2-JB wiring box

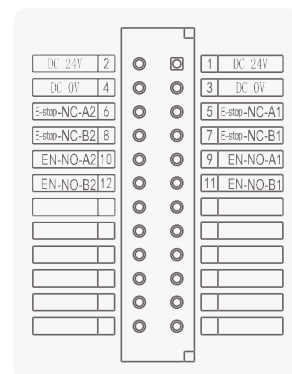

TP2 Wiring diagram

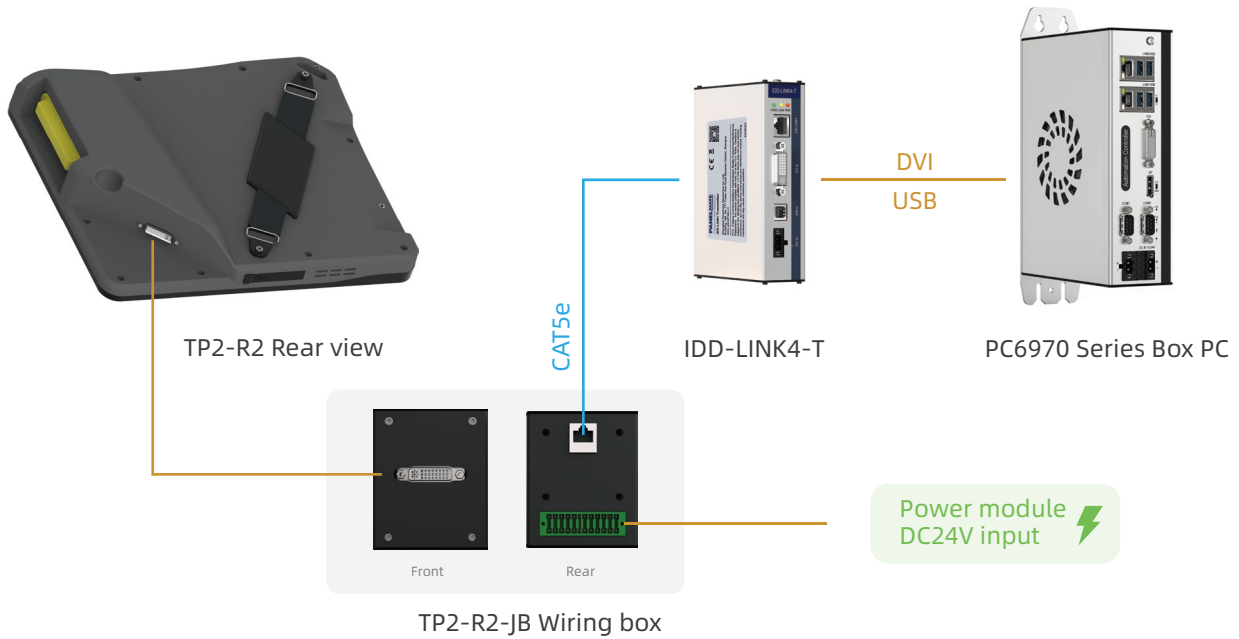

Ordering Information

Part Number	Description
TP2-R2-2K	10.1" TFT LCD / Capacitive touch screen / D24V input / Resolution 1280x800 / Extension button: Emergency stop + Enable button
TP2-R2-5K	10.1" TFT LCD / Capacitive touch screen / D24V input / Resolution 1280x800 / Extension button: Emergency stop + Enable button + 6 shortcut keys
TP2-R2-JB	IDD-LINK4 Wiring box 1 x DVI Out / 1 x RJ45 / 1 x 24pin IO

Optional Accessories

TP2-CB-5	External cable 5m
TP2-CB-10	External cable 10m

Packing List

Wiring box	TP2-R2-JB IDD-LINK4 wiring box
------------	--------------------------------

Note: Package contents are subject to change without prior notice